

ORDERING & TECHNICAL SPECIFICATIONS

February 2010

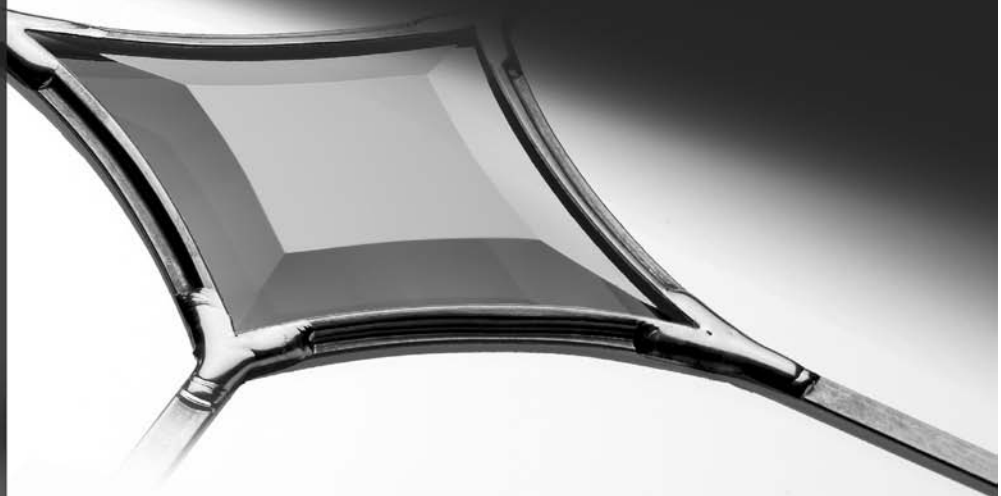

HALLMARK
PANELS LIMITED

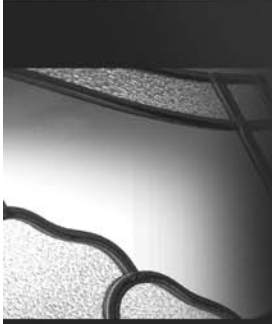
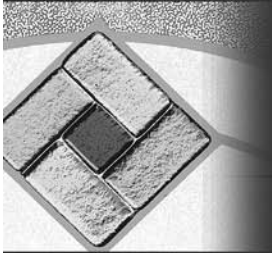

CONTENTS

	Page No
ALHAMBRA	2
AVIGNON	3
ARBURY	4
ARLEY	5
ASTON	6
BELGRAVE	7
BICTON	8
BRAMALL	9
BRISSAC	10
BROLIO	11
BROUGHTON	12
BURGHLEY	13
BURNBY	14
CARLTON CLASSIC	15
CATTON	16
CHAMBORD	17
CHANTILLY	18
CHEVERNY	19
ELSHAM	20
ELTON	21
ELTZ	22
GOODWOOD	23
GOSFIELD	24
HAGLEY	25
HANBURY	26
HARDFORD	27
HEATON	28
KENILWORTH	29
KIRKLEY	30
MANZANARES	31
MARSDEN CLASSIC	32
MONTI	33
NEWBY	34
NORMANBY	35
OAKWELL CLASSIC	36
RAGLEY	37
STANFORD	38
THORESBY	39
WHITLEY	40
WINSLOW	41
SIDE PANELS	42
HALF PANELS	43/44
QUARTER PANELS	45
CONSERVATORY/ HALF PANELS	46
CONSERVATORY PANELS	47/48
FLAT PANELS	
ORDERING	49
VARIATIONS/ CANCELLATION	50
TERMS & CONDITIONS	51

MARSDEN CLASSIC & WHITLEY

As we continue to improve the long term durability of our products we will now be offering 9mm MDF reinforcing as standard in our Whitley and Marsden Classic Range.

CONCAVE PANELS

As we have become aware of instances of visibility through the moulded areas on our concave panels (Stanford, Aston, Arley Broughton, Gosfield and Hardford) depending on the reinforcing supplied. We have made the decision to supply the above named concave panels complete with 4mm MDF reinforcing as standard. This will eliminate any such problems from arising due to the MDF running through the centre of the panel and not directly with the concave part of the moulding.

Please note: This is also recommend in the Houghton Half Panel. MDF cannot be fitted in the centre of a 20mm panel.

TOUGHENED FLEMISH GLASS

Customers are advised to note that "Toughened Flemish Glass" is extremely susceptible to inherent faults such as spasmodic marking and /or distortion. These marks and/or distortion are permanent, and will remain noticeable for the duration of the lifespan of the glass. Orders for Toughened Flemish Glass will only be accepted on the understanding that in the event that the glass is marked and/or distorted, it will be deemed to be of an acceptable quality.

DESIGN LIMITATIONS

Some of our designs you will see from the brochure and reading the special design notes are specifically made and therefore we are unable to alter any part of the designs. Please ensure that you have read and understood the design note before ordering.

PROFILE COLOUR MATCHES

As you are already aware we offer 10 shades of white Pvc, 2

shades of mahogany woodgrain as well as Rosewood and Sherwood Oak. It is important when placing your orders that you supply the correct information relating to the Profile that you are using. If you are unsure of what colour match you may require or your profile company has changed, we will be happy to colour match a sample of your profile for you to ensure that you are supplied the best possible match available.

UNGLAZED PRODUCTS

Please ensure that all units you are manufacturing for unglazed panels are made at the correct thickness 2mm less than the overall thickness of the panel. We have templates that we can supply for our full range of door styles which we suggest you request.

CUT TO SIZE

We offer a cut to size service on all our panel range, it is important that you check size required against the minimum and maximum sizes available on each design. For conservatory panels it is also important to check each cut is available allowing equal measurements each side. All our panels are cut equally both on width and height unless otherwise stated on individual orders. It must be marked clearly for any changes you require. For cut to size flat panels we offer an optimising service and will supply the panels required using the most economical panels with the least wastage.

LETTER PLATE

Hallmark recommend that all letterplate routing has radius corners to avoid potential stress fractures.

TEMPERATURES

Hallmark recommend Panels are cut in temperatures above 12°C.

NETT PRICES

All nett prices are subject to discounts agreed in writing by your Business Development Manager

ORDER FORM

CUSTOMER SPECIFICATION

ROUTE

Invoice Address:
XYZ WINDOWS & DOORS
UNIT 12
MAIN STREET
YORK YO2 4SH

Order No: 0123
Date: 14/3/2005

Delivery Address:
UNIT 12
MAIN STREET
YORK YO2 4SH

Date Required: 24/3/2005
Ref: G WHITE
Contact: J SMITH

SHADED AREA INDICATES GLAZING AREAS

Door: **BELGRAVE**

Panel Type: Solid One

Door Panel Colour/Profile: WHITE C160

Door Panel Thickness: 28 mm Door Panel Quantity: 3

Reinforcing (Tick if required)
4mm Plywood Steel 9mm Mdf Solid Mdf

Cut to size (if required)
Width 675 mm x (Height 1807 mm)
Min Cut: Width 550mm Height: 1570mm

Glass Design Required: DIAMOND LEAD
Backing Glass Pattern: MINSTER

Spacer Bar Colour: _____
Silver Spacer Bar as standard subject to design

Accessories (Tick extras required)

N.B. Letter Plate fitted in midrail as standard. Moved to bottom if knocker supplied

	Urn Knocker	Urn with Spy	Lions Head	Spy Hole	Slim Urn	Slim Urn with Spy	Letter Plate
Gold	<input type="checkbox"/>	<input type="checkbox"/>	Not Available	Not Available	<input type="checkbox"/>	<input type="checkbox"/>	<input checked="" type="checkbox"/>
Brass	<input type="checkbox"/>	<input type="checkbox"/>	Not Available	Not Available	<input type="checkbox"/>	<input type="checkbox"/>	Not Available
Black	<input type="checkbox"/>	<input type="checkbox"/>	Not Available	Not Available	<input type="checkbox"/>	<input type="checkbox"/>	<input type="checkbox"/>
White	<input type="checkbox"/>	<input type="checkbox"/>	Not Available	Not Available	<input type="checkbox"/>	<input type="checkbox"/>	<input type="checkbox"/>
Chrome	<input type="checkbox"/>	<input type="checkbox"/>	Not Available	Not Available	Not Available	Not Available	<input type="checkbox"/>
Silver	<input type="checkbox"/>	<input type="checkbox"/>	Not Available	Not Available	Not Available	Not Available	<input type="checkbox"/>

(Certain accessories not applicable with glazed options)

FAX SALES LINE
01482 701185

PHOTOCOPY THIS SHEET BEFORE COMPLETING & FAXING WITH YOUR OFFICIAL ORDER

Special Instructions if required:

HALLMARK
PANELS LIMITED

Valletta House, Valletta Street, Hedon Road, HALL HU9 5NP
Customer Service: +44 (0)1482 703222, Fax: +44 (0)1482 701185, Reception: +44 (0)1482 781111

All dimensions are approximate and within manufacturing tolerances of + -3mm. However, due to our policy of continuous development, we reserve the right to change specifications without notice

PHOTOCOPY THE SHEET BEFORE COMPLETING & FAX WITH YOUR OFFICIAL ORDER

PLEASE ENSURE ORDERS ARE COMPLETE QUERIES RESULT IN DELAY

CUSTOMER SPECIFICATION

ORDER FORM

ROUTE	
Invoice Address:	Delivery Address:
	Date Required: / /
Order No:	Ref:
Date: / /	Contact:

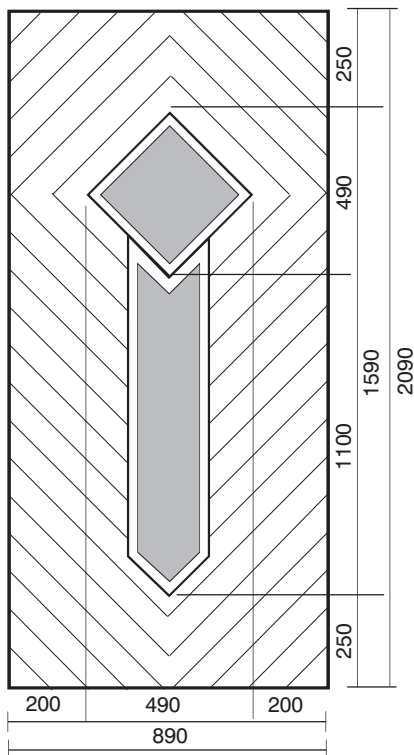

SHADED AREA INDICATES GLAZING AREAS

FAX SALES LINE
01482 701185

PHOTOCOPY THIS SHEET BEFORE COMPLETING & FAXING WITH YOUR OFFICIAL ORDER

Door: ALHAMBRA
Panel Type: Solid <input type="checkbox"/> One <input type="checkbox"/> Two <input type="checkbox"/>
Door Panel Colour/Profile _____
Door Panel Thickness: <input type="text"/> mm Door Panel Quantity: <input type="text"/>
Reinforcing (Tick if required) 4mm Mdf <input type="checkbox"/> Aluminium <input type="checkbox"/> Other options not available on this style
Cut to size (if required) Width _____ mm x (Height _____ mm) Min Cut : Width 560mm Height:1605mm
Glass Design Required: _____
Backing Glass Pattern: _____
Spacer Bar Colour: _____ Silver Spacer Bar as standard subject to design
Accessories Accessories not supplied fitted on this design - can be supplied loose if requested.

Special Instructions if required:

HALLMARK
PANELS LIMITED

Valletta House, Valletta Street, Hedon Road, Hull. HU9 5NP
 Customer Service: +44 (0)1482 703222, Fax: +44 (0)1482 701185, Reception: +44 (0)1482 781111

All dimensions are approximate and within manufacturing tolerances of +/-3mm. However, due to our policy of continuous development, we reserve the right to change specifications without notice

CUSTOMER SPECIFICATION

ORDER FORM

ROUTE	
Invoice Address:	Delivery Address:
	Date Required: / /
Order No:	Ref:
Date: / /	Contact:

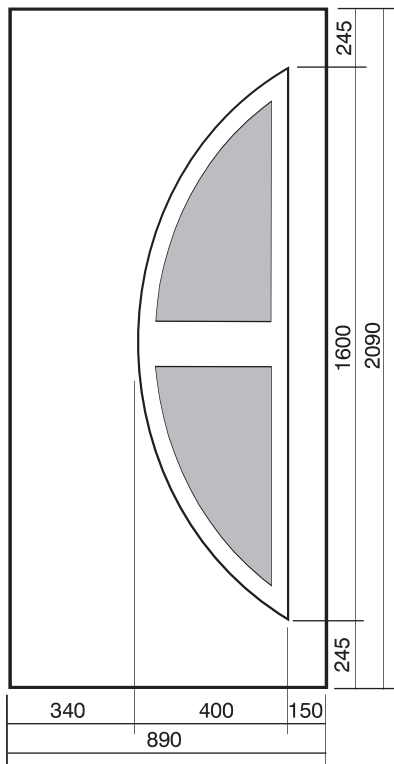

SHADED AREA INDICATES GLAZING AREAS

FAX SALES LINE

**01482
701185**

PHOTOCOPY THIS SHEET
BEFORE COMPLETING &
FAXING WITH YOUR
OFFICIAL ORDER

Door: AVIGNON
Panel Type: Solid <input type="checkbox"/> Two <input type="checkbox"/>
Door Panel Colour/Profile _____
Door Panel Thickness: <input type="text"/> mm Door Panel Quantity: <input type="text"/>
Reinforcing (Tick if required) 4mm Mdf <input type="checkbox"/> Aluminium <input type="checkbox"/> 9mm Mdf <input type="checkbox"/> Solid Mdf <input type="checkbox"/>
Cut to size (if required) Width _____ mm x (Height _____ mm) Min Cut : Width 450mm Height:1650mm
Glass Design Required: _____
Backing Glass Pattern: _____
Spacer Bar Colour: _____ Silver Spacer Bar as standard subject to design
Accessories Accessories not supplied fitted on this design - can be supplied loose if requested.

Special Instructions if required:

CUSTOMER SPECIFICATION

ORDER FORM

ROUTE		
<i>Invoice Address:</i>	<i>Delivery Address:</i>	
	<i>Date Required:</i> / /	
<i>Order No:</i>	<i>Ref:</i>	
<i>Date:</i> / /	<i>Contact:</i>	

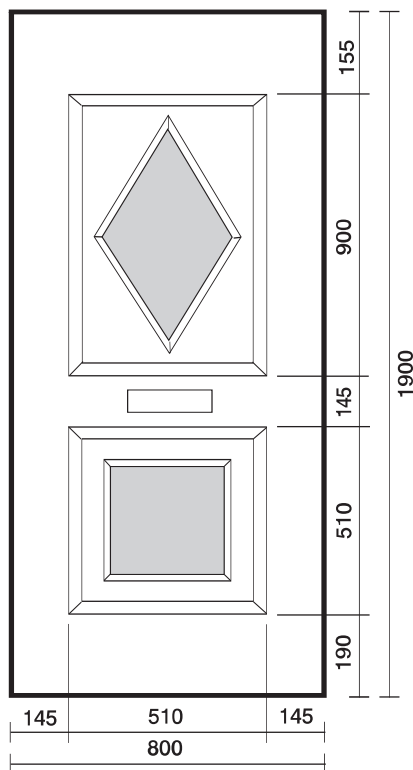

SHADED AREA INDICATES GLAZING AREAS

FAX SALES LINE

01482

701185

PHOTOCOPY THIS SHEET BEFORE COMPLETING & FAXING WITH YOUR OFFICIAL ORDER

Door: ARBURY							
Panel Type: Solid <input type="checkbox"/> One <input type="checkbox"/> Two <input type="checkbox"/>							
Door Panel Colour/Profile _____							
Door Panel Thickness: <input type="text"/> mm		Door Panel Quantity: <input type="text"/>					
Reinforcing (Tick if required)							
4mm Mdf <input type="checkbox"/>		Aluminium <input type="checkbox"/>		9mm Mdf <input type="checkbox"/>		Solid Mdf <input type="checkbox"/>	
Cut to size (if required)							
Width _____ mm x (Height _____ mm)							
Min Cut : Width 560mm Height:1605mm							
Glass Design Required: _____							
Backing Glass Pattern: _____							
Spacer Bar Colour: _____							
Silver Spacer Bar as standard subject to design							
Accessories (Tick extras required)							
<i>N.B. Letter PLate fitted in midrail as standard. Moved to bottom if knocker supplied</i>							
	Urn Knocker	Urn with Spy	Lions Head	Spy Hole	Slim Urn	Slim Urn with Spy	Letter Plate
Gold	<input type="checkbox"/>	<input type="checkbox"/>	Not Available	Not Available	<input type="checkbox"/>	<input type="checkbox"/>	<input type="checkbox"/>
Brass	<input type="checkbox"/>	<input type="checkbox"/>	<input type="checkbox"/>	<input type="checkbox"/>	Not Available	Not Available	Not Available
Black	<input type="checkbox"/>	<input type="checkbox"/>	<input type="checkbox"/>	Not Available	<input type="checkbox"/>	<input type="checkbox"/>	<input type="checkbox"/>
White	<input type="checkbox"/>	<input type="checkbox"/>	<input type="checkbox"/>	Not Available	<input type="checkbox"/>	<input type="checkbox"/>	<input type="checkbox"/>
Chrome	<input type="checkbox"/>	<input type="checkbox"/>	Not Available	<input type="checkbox"/>	Not Available	Not Available	<input type="checkbox"/>
Silver	<input type="checkbox"/>	<input type="checkbox"/>	Not Available	Not Available	Not Available	Not Available	<input type="checkbox"/>
(Certain accessories not applicable with glazed options)							

Special Instructions if required:

HALLMARK
PANELS LIMITED

Valletta House, Valletta Street, Hedon Road, Hull. HU9 5NP
Customer Service: +44 (0)1482 703222, Fax: +44 (0)1482 701185, Reception: +44 (0)1482 781111

All dimensions are approximate and within manufacturing tolerances of +/-3mm. However, due to our policy of continuous development, we reserve the right to change specifications without notice

CUSTOMER SPECIFICATION

ORDER FORM

ROUTE		
<i>Invoice Address:</i>	<i>Delivery Address:</i>	
<i>Order No.:</i>	<i>Date Required:</i> / /	
<i>Date:</i> / /	<i>Ref:</i>	
		<i>Contact:</i>

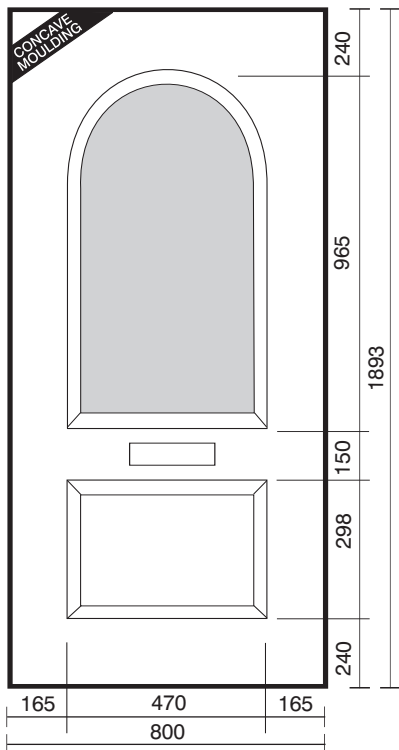

SHADED AREA INDICATES GLAZING AREAS

FAX SALES LINE

**01482
701185**

**PHOTOCOPY THIS SHEET
BEFORE COMPLETING &
FAXING WITH YOUR
OFFICIAL ORDER**

Door: ARLEY							
<i>Panel Type:</i> Solid <input type="checkbox"/> One <input type="checkbox"/>							
<i>Door Panel Colour/Profile</i> _____							
<i>Door Panel Thickness:</i> <input type="text"/> mm				<i>Door Panel Quantity:</i> <input type="text"/>			
<i>Reinforcing with 4mm MDF as standard</i>							
<i>Cut to size (if required)</i> Width _____ mm x (Height _____ mm) Min Cut : Width 520mm Height:1585mm							
<i>Glass Design Required:</i> _____							
<i>Backing Glass Pattern:</i> _____							
<i>Spacer Bar Colour:</i> _____ <i>Silver Spacer Bar as standard subject to design</i>							
Accessories (Tick extras required)							
<i>N.B. Letter PLate fitted in midrail as standard. Moved to bottom if knocker supplied</i>							
	<i>Urn Knocker</i>	<i>Urn with Spy</i>	<i>Lions Head</i>	<i>Spy Hole</i>	<i>Slim Um</i>	<i>Slim Urn with Spy</i>	<i>Letter Plate</i>
<i>Gold</i>	<input type="checkbox"/>	<input type="checkbox"/>	Not Available	Not Available	<input type="checkbox"/>	<input type="checkbox"/>	<input type="checkbox"/>
<i>Brass</i>	<input type="checkbox"/>	<input type="checkbox"/>	<input type="checkbox"/>	<input type="checkbox"/>	Not Available	Not Available	Not Available
<i>Black</i>	<input type="checkbox"/>	<input type="checkbox"/>	<input type="checkbox"/>	Not Available	<input type="checkbox"/>	<input type="checkbox"/>	<input type="checkbox"/>
<i>White</i>	<input type="checkbox"/>	<input type="checkbox"/>	<input type="checkbox"/>	Not Available	<input type="checkbox"/>	<input type="checkbox"/>	<input type="checkbox"/>
<i>Chrome</i>	<input type="checkbox"/>	<input type="checkbox"/>	Not Available	<input type="checkbox"/>	Not Available	Not Available	<input type="checkbox"/>
<i>Silver</i>	<input type="checkbox"/>	<input type="checkbox"/>	Not Available	Not Available	Not Available	Not Available	<input type="checkbox"/>
<i>(Certain accessories not applicable with glazed options)</i>							

Special Instructions if required:

CUSTOMER SPECIFICATION

ORDER FORM

ROUTE		
Invoice Address:	Delivery Address:	
	Date Required: / /	
Order No:	Ref:	
Date: / /	Contact:	

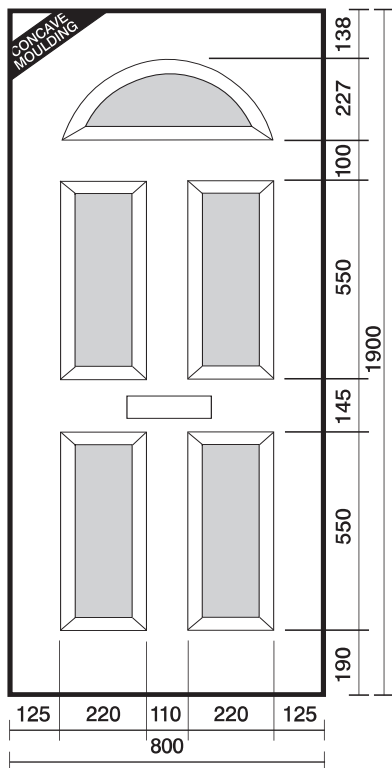

SHADED AREA INDICATES GLAZING AREAS

FAX SALES LINE

01482

701185

PHOTOCOPY THIS SHEET BEFORE COMPLETING & FAXING WITH YOUR OFFICIAL ORDER

Door: ASTON							
Panel Type: Solid <input type="checkbox"/> One <input type="checkbox"/> Three <input type="checkbox"/> Five <input type="checkbox"/>							
Door Panel Colour/Profile _____							
Door Panel Thickness: <input type="text"/> mm		Door Panel Quantity: <input type="text"/>					
Reinforcing with 4mm Mdf as standard							
Cut to size (if required) Width _____ mm x (Height _____ mm) Min Cut : Width 600mm Height:1622mm							
Glass Design Required: _____							
Backing Glass Pattern: _____							
Spacer Bar Colour: _____ Silver Spacer Bar as standard subject to design							
Accessories (Tick extras required)							
<i>N.B. Letter PLate fitted in midrail as standard.</i>							
	Urn Knocker	Urn with Spy	Lions Head	Spy Hole	Slim Um	Slim Urn with Spy	Letter Plate
Gold	<input type="checkbox"/>	<input type="checkbox"/>	Not Available	Not Available	<input type="checkbox"/>	<input type="checkbox"/>	<input type="checkbox"/>
Brass	<input type="checkbox"/>	<input type="checkbox"/>	<input type="checkbox"/>	<input type="checkbox"/>	Not Available	Not Available	Not Available
Black	<input type="checkbox"/>	<input type="checkbox"/>	<input type="checkbox"/>	Not Available	<input type="checkbox"/>	<input type="checkbox"/>	<input type="checkbox"/>
White	<input type="checkbox"/>	<input type="checkbox"/>	<input type="checkbox"/>	Not Available	<input type="checkbox"/>	<input type="checkbox"/>	<input type="checkbox"/>
Chrome	<input type="checkbox"/>	<input type="checkbox"/>	Not Available	<input type="checkbox"/>	Not Available	Not Available	<input type="checkbox"/>
Silver	<input type="checkbox"/>	<input type="checkbox"/>	Not Available	Not Available	Not Available	Not Available	<input type="checkbox"/>
<i>(Certain accessories not applicable with glazed options)</i>							

Special Instructions if required:

HALLMARK
PANELS LIMITED

Valletta House, Valletta Street, Hedon Road, Hull. HU9 5NP
Customer Service: +44 (0)1482 703222, Fax: +44 (0)1482 701185, Reception: +44 (0)1482 781111

All dimensions are approximate and within manufacturing tolerances of +/-3mm. However, due to our policy of continuous development, we reserve the right to change specifications without notice

CUSTOMER SPECIFICATION

ORDER FORM

ROUTE		
Invoice Address:	Delivery Address:	
	Date Required: / /	
Order No:	Ref:	
Date: / /	Contact:	

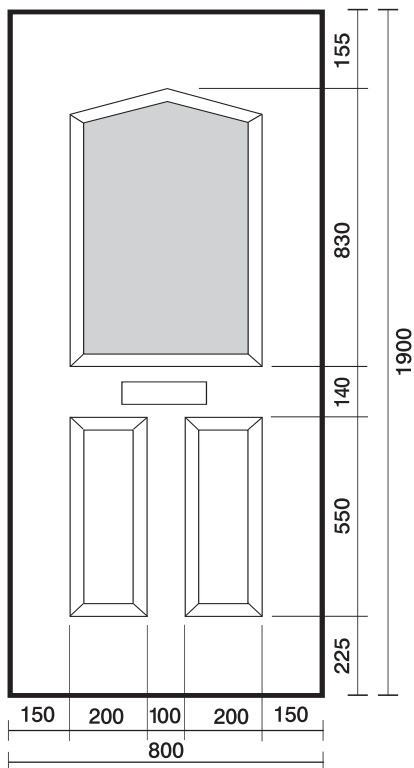

SHADED AREA INDICATES GLAZING AREAS

FAX SALES LINE

01482

701185

PHOTOCOPY THIS SHEET BEFORE COMPLETING & FAXING WITH YOUR OFFICIAL ORDER

Door: BELGRAVE							
Panel Type: Solid <input type="checkbox"/> One <input type="checkbox"/>							
Door Panel Colour/Profile _____							
Door Panel Thickness: <input type="text"/> mm				Door Panel Quantity: <input type="text"/>			
Reinforcing (Tick if required)							
4mm Mdf <input type="checkbox"/>		Aluminium <input type="checkbox"/>		9mm Mdf <input type="checkbox"/>		Solid Mdf <input type="checkbox"/>	
Cut to size (if required)							
Width _____ mm x (Height _____ mm)							
Min Cut : Width 550mm Height:1570mm							
Glass Design Required: _____							
Backing Glass Pattern: _____							
Spacer Bar Colour: _____							
Silver Spacer Bar as standard subject to design							
Accessories (Tick extras required)							
<i>N.B. Letter PLate fitted in midrail as standard. Moved to bottom if knocker supplied</i>							
	Urn Knocker	Urn with Spy	Lions Head	Spy Hole	Slim Um	Slim Urn with Spy	Letter Plate
Gold	<input type="checkbox"/>	<input type="checkbox"/>	Not Available	Not Available	<input type="checkbox"/>	<input type="checkbox"/>	<input type="checkbox"/>
Brass	<input type="checkbox"/>	<input type="checkbox"/>	<input type="checkbox"/>	<input type="checkbox"/>	Not Available	Not Available	Not Available
Black	<input type="checkbox"/>	<input type="checkbox"/>	<input type="checkbox"/>	Not Available	<input type="checkbox"/>	<input type="checkbox"/>	<input type="checkbox"/>
White	<input type="checkbox"/>	<input type="checkbox"/>	<input type="checkbox"/>	Not Available	<input type="checkbox"/>	<input type="checkbox"/>	<input type="checkbox"/>
Chrome	<input type="checkbox"/>	<input type="checkbox"/>	Not Available	<input type="checkbox"/>	Not Available	Not Available	<input type="checkbox"/>
Silver	<input type="checkbox"/>	<input type="checkbox"/>	Not Available	Not Available	Not Available	Not Available	<input type="checkbox"/>
(Certain accessories not applicable with glazed options)							

Special Instructions if required:

CUSTOMER SPECIFICATION

ORDER FORM

ROUTE		
Invoice Address:	Delivery Address:	
	Date Required: / /	
Order No:	Ref:	
Date: / /	Contact:	

All panels will be manufactured to our standard size BICTON unless otherwise stated.

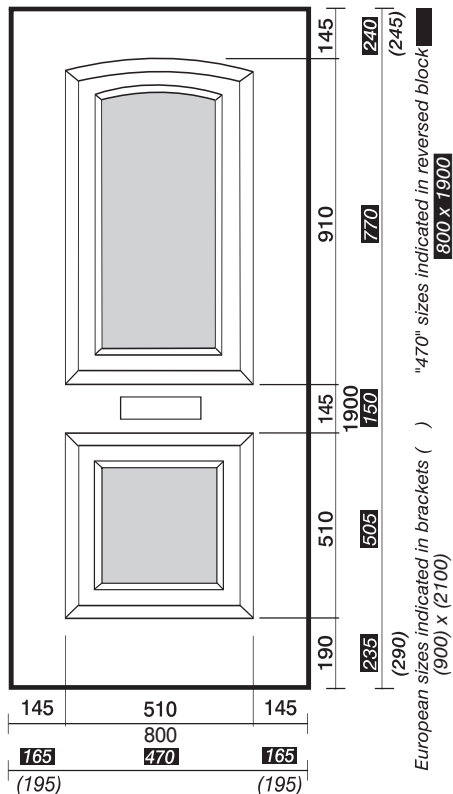

Door: BICTON <input type="checkbox"/> BICTON "470" <input type="checkbox"/> BICTON EURO <input type="checkbox"/>																																																									
Panel Type: Solid <input type="checkbox"/> One <input type="checkbox"/> Two <input type="checkbox"/>																																																									
Door Panel Colour/Profile _____																																																									
Door Panel Thickness: _____ mm	Door Panel Quantity: _____																																																								
Reinforcing (Tick if required)																																																									
4mm Mdf <input type="checkbox"/>	Aluminium <input type="checkbox"/>																																																								
9mm Mdf <input type="checkbox"/>	Solid Mdf <input type="checkbox"/>																																																								
Cut to size (if required)																																																									
Width _____ mm x (Height _____ mm)																																																									
Min Cut : Standard W: 560mm H:1615mm 470 W: 520mm H:1475mm																																																									
Glass Design Required: _____																																																									
Backing Glass Pattern: _____																																																									
Spacer Bar Colour: _____																																																									
Silver Spacer Bar as standard subject to design																																																									
Accessories (Tick extras required)																																																									
N.B. Letter PLate fitted in midrail as standard. Moved to bottom if knocker supplied																																																									
	<table border="1" style="width: 100%; border-collapse: collapse; font-size: x-small;"> <thead> <tr> <th></th> <th>Urn Knocker</th> <th>Urn with Spy</th> <th>Lions Head</th> <th>Spy Hole</th> <th>Slim Urn</th> <th>Slim Urn with Spy</th> <th>Letter Plate</th> </tr> </thead> <tbody> <tr> <td>Gold</td> <td><input type="checkbox"/></td> <td><input type="checkbox"/></td> <td>Not Available</td> <td>Not Available</td> <td><input type="checkbox"/></td> <td><input type="checkbox"/></td> <td><input type="checkbox"/></td> </tr> <tr> <td>Brass</td> <td><input type="checkbox"/></td> <td><input type="checkbox"/></td> <td><input type="checkbox"/></td> <td><input type="checkbox"/></td> <td>Not Available</td> <td>Not Available</td> <td>Not Available</td> </tr> <tr> <td>Black</td> <td><input type="checkbox"/></td> <td><input type="checkbox"/></td> <td><input type="checkbox"/></td> <td>Not Available</td> <td><input type="checkbox"/></td> <td><input type="checkbox"/></td> <td><input type="checkbox"/></td> </tr> <tr> <td>White</td> <td><input type="checkbox"/></td> <td><input type="checkbox"/></td> <td><input type="checkbox"/></td> <td>Not Available</td> <td><input type="checkbox"/></td> <td><input type="checkbox"/></td> <td><input type="checkbox"/></td> </tr> <tr> <td>Chrome</td> <td><input type="checkbox"/></td> <td><input type="checkbox"/></td> <td>Not Available</td> <td><input type="checkbox"/></td> <td>Not Available</td> <td>Not Available</td> <td><input type="checkbox"/></td> </tr> <tr> <td>Silver</td> <td><input type="checkbox"/></td> <td><input type="checkbox"/></td> <td>Not Available</td> <td>Not Available</td> <td>Not Available</td> <td>Not Available</td> <td><input type="checkbox"/></td> </tr> </tbody> </table>		Urn Knocker	Urn with Spy	Lions Head	Spy Hole	Slim Urn	Slim Urn with Spy	Letter Plate	Gold	<input type="checkbox"/>	<input type="checkbox"/>	Not Available	Not Available	<input type="checkbox"/>	<input type="checkbox"/>	<input type="checkbox"/>	Brass	<input type="checkbox"/>	<input type="checkbox"/>	<input type="checkbox"/>	<input type="checkbox"/>	Not Available	Not Available	Not Available	Black	<input type="checkbox"/>	<input type="checkbox"/>	<input type="checkbox"/>	Not Available	<input type="checkbox"/>	<input type="checkbox"/>	<input type="checkbox"/>	White	<input type="checkbox"/>	<input type="checkbox"/>	<input type="checkbox"/>	Not Available	<input type="checkbox"/>	<input type="checkbox"/>	<input type="checkbox"/>	Chrome	<input type="checkbox"/>	<input type="checkbox"/>	Not Available	<input type="checkbox"/>	Not Available	Not Available	<input type="checkbox"/>	Silver	<input type="checkbox"/>	<input type="checkbox"/>	Not Available	Not Available	Not Available	Not Available	<input type="checkbox"/>
	Urn Knocker	Urn with Spy	Lions Head	Spy Hole	Slim Urn	Slim Urn with Spy	Letter Plate																																																		
Gold	<input type="checkbox"/>	<input type="checkbox"/>	Not Available	Not Available	<input type="checkbox"/>	<input type="checkbox"/>	<input type="checkbox"/>																																																		
Brass	<input type="checkbox"/>	<input type="checkbox"/>	<input type="checkbox"/>	<input type="checkbox"/>	Not Available	Not Available	Not Available																																																		
Black	<input type="checkbox"/>	<input type="checkbox"/>	<input type="checkbox"/>	Not Available	<input type="checkbox"/>	<input type="checkbox"/>	<input type="checkbox"/>																																																		
White	<input type="checkbox"/>	<input type="checkbox"/>	<input type="checkbox"/>	Not Available	<input type="checkbox"/>	<input type="checkbox"/>	<input type="checkbox"/>																																																		
Chrome	<input type="checkbox"/>	<input type="checkbox"/>	Not Available	<input type="checkbox"/>	Not Available	Not Available	<input type="checkbox"/>																																																		
Silver	<input type="checkbox"/>	<input type="checkbox"/>	Not Available	Not Available	Not Available	Not Available	<input type="checkbox"/>																																																		
(Certain accessories not applicable with glazed options)																																																									

SHADED AREA INDICATES GLAZING AREAS

FAX SALES LINE

01482 701185

PHOTOCOPY THIS SHEET BEFORE COMPLETING & FAXING WITH YOUR OFFICIAL ORDER

Special Instructions if required: Euro 470 not available

HALLMARK
PANELS LIMITED

Valletta House, Valletta Street, Hedon Road, Hull. HU9 5NP
Customer Service: +44 (0)1482 703222, Fax: +44 (0)1482 701185, Reception: +44 (0)1482 781111

All dimensions are approximate and within manufacturing tolerances of +/-3mm. However, due to our policy of continuous development, we reserve the right to change specifications without notice

CUSTOMER SPECIFICATION

ORDER FORM

ROUTE		
Invoice Address:	Delivery Address:	
	Date Required: / /	
Order No:	Ref:	
Date: / /	Contact:	

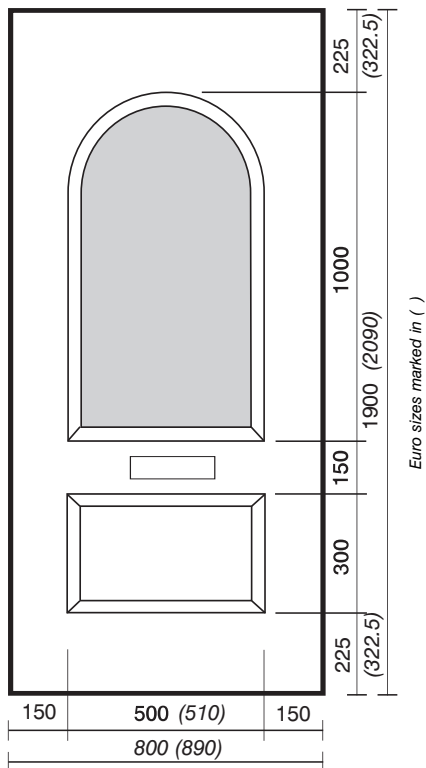

SHADED AREA INDICATES GLAZING AREAS

FAX SALES LINE

01482 701185

PHOTOCOPY THIS SHEET BEFORE COMPLETING & FAXING WITH YOUR OFFICIAL ORDER

Door: BRAMALL <input type="checkbox"/> BRAMALL EURO <input type="checkbox"/>																																																									
Panel Type: Solid <input type="checkbox"/> One <input type="checkbox"/>																																																									
Door Panel Colour/Profile _____																																																									
Door Panel Thickness: <input type="text"/> mm	Door Panel Quantity: <input type="text"/>																																																								
Reinforcing (Tick if required)																																																									
4mm Mdf <input type="checkbox"/>	Aluminium <input type="checkbox"/>																																																								
9mm Mdf <input type="checkbox"/>	Solid Mdf <input type="checkbox"/>																																																								
Cut to size (if required)																																																									
Width _____ mm x (Height _____ mm)																																																									
Min Cut : Standard W:550mm H:1500mm Euro W:800mm H:1900mm																																																									
Glass Design Required: _____																																																									
Backing Glass Pattern: _____																																																									
Spacer Bar Colour: _____																																																									
Silver Spacer Bar as standard subject to design																																																									
Accessories (Tick extras required)																																																									
<i>N.B. Letter PLate fitted in midrail as standard. Moved to bottom if knocker supplied</i>																																																									
	<table border="1" style="width: 100%; border-collapse: collapse;"> <thead> <tr> <th></th> <th>Urn Knocker</th> <th>Urn with Spy</th> <th>Lions Head</th> <th>Spy Hole</th> <th>Slim Urn</th> <th>Slim Urn with Spy</th> <th>Letter Plate</th> </tr> </thead> <tbody> <tr> <td>Gold</td> <td><input type="checkbox"/></td> <td><input type="checkbox"/></td> <td>Not Available</td> <td>Not Available</td> <td><input type="checkbox"/></td> <td><input type="checkbox"/></td> <td><input type="checkbox"/></td> </tr> <tr> <td>Brass</td> <td><input type="checkbox"/></td> <td><input type="checkbox"/></td> <td><input type="checkbox"/></td> <td><input type="checkbox"/></td> <td>Not Available</td> <td>Not Available</td> <td>Not Available</td> </tr> <tr> <td>Black</td> <td><input type="checkbox"/></td> <td><input type="checkbox"/></td> <td><input type="checkbox"/></td> <td>Not Available</td> <td><input type="checkbox"/></td> <td><input type="checkbox"/></td> <td><input type="checkbox"/></td> </tr> <tr> <td>White</td> <td><input type="checkbox"/></td> <td><input type="checkbox"/></td> <td><input type="checkbox"/></td> <td>Not Available</td> <td><input type="checkbox"/></td> <td><input type="checkbox"/></td> <td><input type="checkbox"/></td> </tr> <tr> <td>Chrome</td> <td><input type="checkbox"/></td> <td><input type="checkbox"/></td> <td>Not Available</td> <td><input type="checkbox"/></td> <td>Not Available</td> <td>Not Available</td> <td><input type="checkbox"/></td> </tr> <tr> <td>Silver</td> <td><input type="checkbox"/></td> <td><input type="checkbox"/></td> <td>Not Available</td> <td>Not Available</td> <td>Not Available</td> <td>Not Available</td> <td><input type="checkbox"/></td> </tr> </tbody> </table>		Urn Knocker	Urn with Spy	Lions Head	Spy Hole	Slim Urn	Slim Urn with Spy	Letter Plate	Gold	<input type="checkbox"/>	<input type="checkbox"/>	Not Available	Not Available	<input type="checkbox"/>	<input type="checkbox"/>	<input type="checkbox"/>	Brass	<input type="checkbox"/>	<input type="checkbox"/>	<input type="checkbox"/>	<input type="checkbox"/>	Not Available	Not Available	Not Available	Black	<input type="checkbox"/>	<input type="checkbox"/>	<input type="checkbox"/>	Not Available	<input type="checkbox"/>	<input type="checkbox"/>	<input type="checkbox"/>	White	<input type="checkbox"/>	<input type="checkbox"/>	<input type="checkbox"/>	Not Available	<input type="checkbox"/>	<input type="checkbox"/>	<input type="checkbox"/>	Chrome	<input type="checkbox"/>	<input type="checkbox"/>	Not Available	<input type="checkbox"/>	Not Available	Not Available	<input type="checkbox"/>	Silver	<input type="checkbox"/>	<input type="checkbox"/>	Not Available	Not Available	Not Available	Not Available	<input type="checkbox"/>
	Urn Knocker	Urn with Spy	Lions Head	Spy Hole	Slim Urn	Slim Urn with Spy	Letter Plate																																																		
Gold	<input type="checkbox"/>	<input type="checkbox"/>	Not Available	Not Available	<input type="checkbox"/>	<input type="checkbox"/>	<input type="checkbox"/>																																																		
Brass	<input type="checkbox"/>	<input type="checkbox"/>	<input type="checkbox"/>	<input type="checkbox"/>	Not Available	Not Available	Not Available																																																		
Black	<input type="checkbox"/>	<input type="checkbox"/>	<input type="checkbox"/>	Not Available	<input type="checkbox"/>	<input type="checkbox"/>	<input type="checkbox"/>																																																		
White	<input type="checkbox"/>	<input type="checkbox"/>	<input type="checkbox"/>	Not Available	<input type="checkbox"/>	<input type="checkbox"/>	<input type="checkbox"/>																																																		
Chrome	<input type="checkbox"/>	<input type="checkbox"/>	Not Available	<input type="checkbox"/>	Not Available	Not Available	<input type="checkbox"/>																																																		
Silver	<input type="checkbox"/>	<input type="checkbox"/>	Not Available	Not Available	Not Available	Not Available	<input type="checkbox"/>																																																		
(Certain accessories not applicable with glazed options)																																																									

Special Instructions if required:

CUSTOMER SPECIFICATION

ORDER FORM

ROUTE	
Invoice Address:	Delivery Address:
	Date Required: / /
Order No:	Ref:
Date: / /	Contact:

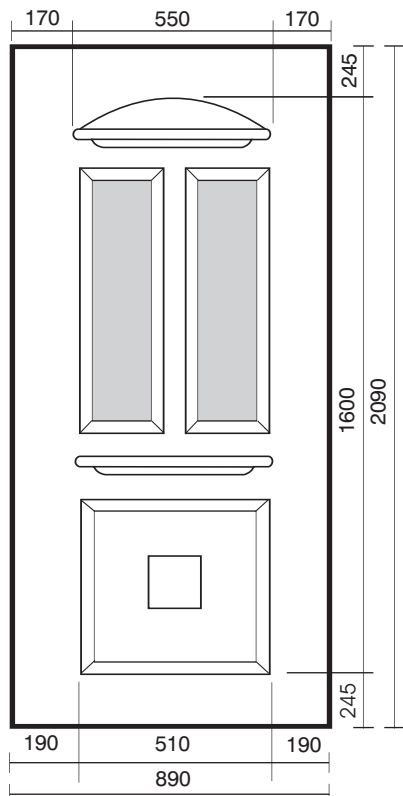

SHADED AREA INDICATES GLAZING AREAS

FAX SALES LINE

01482
701185

PHOTOCOPY THIS SHEET
BEFORE COMPLETING &
FAXING WITH YOUR
OFFICIAL ORDER

Door: BRISSAC
Panel Type: Solid <input type="checkbox"/> Two <input type="checkbox"/>
Door Panel Colour/Profile _____
Door Panel Thickness: <input type="text"/> mm Door Panel Quantity: <input type="text"/>
Reinforcing (Tick if required) 4mm Mdf <input type="checkbox"/> Aluminium <input type="checkbox"/> 9mm Mdf <input type="checkbox"/> Solid Mdf <input type="checkbox"/>
Cut to size (if required) Width _____ mm x (Height _____ mm) Min Cut : Width 560mm Height:1650mm
Glass Design Required: _____
Backing Glass Pattern: _____
Spacer Bar Colour: _____ Silver Spacer Bar as standard subject to design
Accessories Accessories not supplied fitted on this design - can be supplied loose if requested.

Special Instructions if required:

HALLMARK
PANELS LIMITED

Valletta House, Valletta Street, Hedon Road, Hull. HU9 5NP
Customer Service: +44 (0)1482 703222, Fax: +44 (0)1482 701185, Reception: +44 (0)1482 781111

All dimensions are approximate and within manufacturing tolerances of +/-3mm. However, due to our policy of continuous development, we reserve the right to change specifications without notice

CUSTOMER SPECIFICATION

ORDER FORM

ROUTE	
Invoice Address:	Delivery Address:
Order No:	Date Required: / /
Date: / /	Ref:
	Contact:

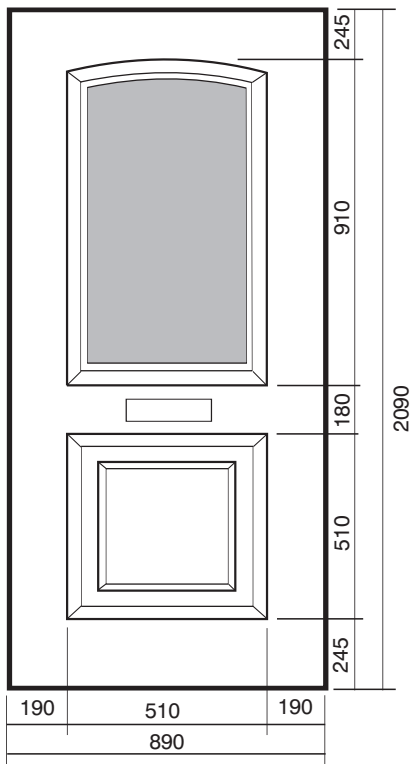

SHADED AREA INDICATES GLAZING AREAS

FAX SALES LINE

01482 701185

PHOTOCOPY THIS SHEET BEFORE COMPLETING & FAXING WITH YOUR OFFICIAL ORDER

Door: BROLIO							
Panel Type: Solid <input type="checkbox"/> One <input type="checkbox"/>							
Door Panel Colour/Profile _____							
Door Panel Thickness: _____ mm				Door Panel Quantity: _____			
Reinforcing (Tick if required)							
4mm Mdf <input type="checkbox"/>		Aluminium <input type="checkbox"/>		9mm Mdf <input type="checkbox"/>		Solid Mdf <input type="checkbox"/>	
Cut to size (if required)							
Width _____ mm x (Height _____ mm)							
Min Cut : Width 560mm Height:1650mm							
Glass Design Required: _____							
Backing Glass Pattern: _____							
Spacer Bar Colour: _____							
Silver Spacer Bar as standard subject to design							
Accessories (Tick extras required)							
N.B. Letter PLate fitted in midrail as standard.							
	Urn Knocker	Urn with Spy	Lions Head	Spy Hole	Slim Urn	Slim Urn with Spy	Letter Plate
Gold	<input type="checkbox"/>	<input type="checkbox"/>	Not Available	Not Available	<input type="checkbox"/>	<input type="checkbox"/>	<input type="checkbox"/>
Brass	<input type="checkbox"/>	<input type="checkbox"/>	<input type="checkbox"/>	<input type="checkbox"/>	Not Available	Not Available	Not Available
Black	<input type="checkbox"/>	<input type="checkbox"/>	<input type="checkbox"/>	Not Available	<input type="checkbox"/>	<input type="checkbox"/>	<input type="checkbox"/>
White	<input type="checkbox"/>	<input type="checkbox"/>	<input type="checkbox"/>	Not Available	<input type="checkbox"/>	<input type="checkbox"/>	<input type="checkbox"/>
Chrome	<input type="checkbox"/>	<input type="checkbox"/>	Not Available	<input type="checkbox"/>	Not Available	Not Available	<input type="checkbox"/>
Silver	<input type="checkbox"/>	<input type="checkbox"/>	Not Available	Not Available	Not Available	Not Available	<input type="checkbox"/>
(Certain accessories not applicable with glazed options)							

Special Instructions if required:

CUSTOMER SPECIFICATION

ORDER FORM

ROUTE	
Invoice Address:	Delivery Address:
Order No:	Date Required: / /
Date: / /	Ref:
	Contact:

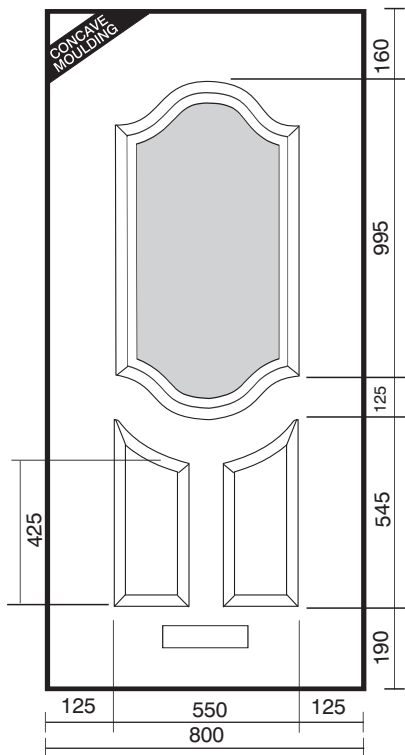

SHADED AREA INDICATES GLAZING AREAS

FAX SALES LINE

01482 701185

PHOTOCOPY THIS SHEET BEFORE COMPLETING & FAXING WITH YOUR OFFICIAL ORDER

Door: BROUGHTON																																																								
Panel Type: Solid (as Gosfield) <input type="checkbox"/> One																																																								
Door Panel Colour/Profile _____																																																								
Door Panel Thickness: <input type="text"/> mm Door Panel Quantity: <input type="text"/>																																																								
Reinforcing with 4mm MDF as standard																																																								
Cut to size (if required) Width _____ mm x (Height _____ mm) Min Cut : Width 600mm Height:1715mm																																																								
Glass Design Required: _____																																																								
Backing Glass Pattern: _____																																																								
Spacer Bar Colour: _____ Silver Spacer Bar as standard subject to design																																																								
Accessories (Tick extras required)																																																								
<i>N.B. Letter PLate fitted in Base rail as standard.</i>																																																								
<table border="1"> <thead> <tr> <th></th> <th>Urn Knocker</th> <th>Urn with Spy</th> <th>Lions Head</th> <th>Spy Hole</th> <th>Slim Um</th> <th>Slim Urn with Spy</th> <th>Letter Plate</th> </tr> </thead> <tbody> <tr> <td>Gold</td> <td><input type="checkbox"/></td> <td><input type="checkbox"/></td> <td>Not Available</td> <td>Not Available</td> <td><input type="checkbox"/></td> <td><input type="checkbox"/></td> <td><input type="checkbox"/></td> </tr> <tr> <td>Brass</td> <td><input type="checkbox"/></td> <td><input type="checkbox"/></td> <td><input type="checkbox"/></td> <td><input type="checkbox"/></td> <td>Not Available</td> <td>Not Available</td> <td>Not Available</td> </tr> <tr> <td>Black</td> <td><input type="checkbox"/></td> <td><input type="checkbox"/></td> <td><input type="checkbox"/></td> <td>Not Available</td> <td><input type="checkbox"/></td> <td><input type="checkbox"/></td> <td><input type="checkbox"/></td> </tr> <tr> <td>White</td> <td><input type="checkbox"/></td> <td><input type="checkbox"/></td> <td><input type="checkbox"/></td> <td>Not Available</td> <td><input type="checkbox"/></td> <td><input type="checkbox"/></td> <td><input type="checkbox"/></td> </tr> <tr> <td>Chrome</td> <td><input type="checkbox"/></td> <td><input type="checkbox"/></td> <td>Not Available</td> <td><input type="checkbox"/></td> <td>Not Available</td> <td>Not Available</td> <td><input type="checkbox"/></td> </tr> <tr> <td>Silver</td> <td><input type="checkbox"/></td> <td><input type="checkbox"/></td> <td>Not Available</td> <td>Not Available</td> <td>Not Available</td> <td>Not Available</td> <td><input type="checkbox"/></td> </tr> </tbody> </table>		Urn Knocker	Urn with Spy	Lions Head	Spy Hole	Slim Um	Slim Urn with Spy	Letter Plate	Gold	<input type="checkbox"/>	<input type="checkbox"/>	Not Available	Not Available	<input type="checkbox"/>	<input type="checkbox"/>	<input type="checkbox"/>	Brass	<input type="checkbox"/>	<input type="checkbox"/>	<input type="checkbox"/>	<input type="checkbox"/>	Not Available	Not Available	Not Available	Black	<input type="checkbox"/>	<input type="checkbox"/>	<input type="checkbox"/>	Not Available	<input type="checkbox"/>	<input type="checkbox"/>	<input type="checkbox"/>	White	<input type="checkbox"/>	<input type="checkbox"/>	<input type="checkbox"/>	Not Available	<input type="checkbox"/>	<input type="checkbox"/>	<input type="checkbox"/>	Chrome	<input type="checkbox"/>	<input type="checkbox"/>	Not Available	<input type="checkbox"/>	Not Available	Not Available	<input type="checkbox"/>	Silver	<input type="checkbox"/>	<input type="checkbox"/>	Not Available	Not Available	Not Available	Not Available	<input type="checkbox"/>
	Urn Knocker	Urn with Spy	Lions Head	Spy Hole	Slim Um	Slim Urn with Spy	Letter Plate																																																	
Gold	<input type="checkbox"/>	<input type="checkbox"/>	Not Available	Not Available	<input type="checkbox"/>	<input type="checkbox"/>	<input type="checkbox"/>																																																	
Brass	<input type="checkbox"/>	<input type="checkbox"/>	<input type="checkbox"/>	<input type="checkbox"/>	Not Available	Not Available	Not Available																																																	
Black	<input type="checkbox"/>	<input type="checkbox"/>	<input type="checkbox"/>	Not Available	<input type="checkbox"/>	<input type="checkbox"/>	<input type="checkbox"/>																																																	
White	<input type="checkbox"/>	<input type="checkbox"/>	<input type="checkbox"/>	Not Available	<input type="checkbox"/>	<input type="checkbox"/>	<input type="checkbox"/>																																																	
Chrome	<input type="checkbox"/>	<input type="checkbox"/>	Not Available	<input type="checkbox"/>	Not Available	Not Available	<input type="checkbox"/>																																																	
Silver	<input type="checkbox"/>	<input type="checkbox"/>	Not Available	Not Available	Not Available	Not Available	<input type="checkbox"/>																																																	
(Certain accessories not applicable with glazed options)																																																								

Special Instructions if required:

HALLMARK PANELS LIMITED

Valletta House, Valletta Street, Hedon Road, Hull. HU9 5NP
Customer Service: +44 (0)1482 703222, Fax: +44 (0)1482 701185, Reception: +44 (0)1482 781111

All dimensions are approximate and within manufacturing tolerances of +/-3mm. However, due to our policy of continuous development, we reserve the right to change specifications without notice

CUSTOMER SPECIFICATION

ORDER FORM

ROUTE		
Invoice Address:	Delivery Address:	
	Date Required: / /	
Order No:	Ref:	
Date: / /	Contact:	

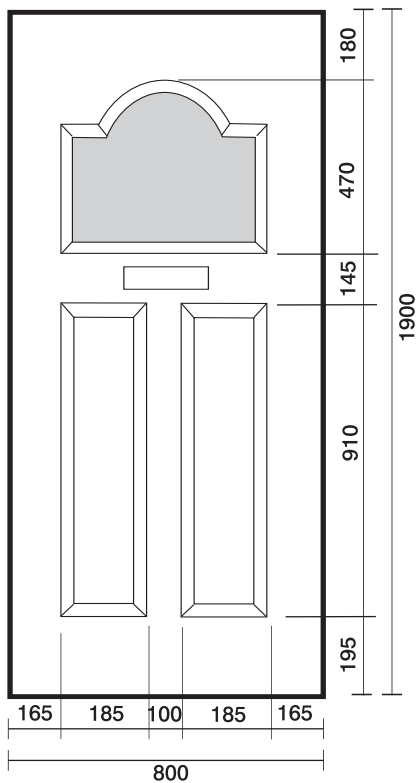

SHADED AREA INDICATES GLAZING AREAS

FAX SALES LINE

01482

701185

PHOTOCOPY THIS SHEET BEFORE COMPLETING & FAXING WITH YOUR OFFICIAL ORDER

Door: BURGLEY							
Panel Type: Solid <input type="checkbox"/> One <input type="checkbox"/>							
Door Panel Colour/Profile _____							
Door Panel Thickness: <input type="text"/> mm		Door Panel Quantity: <input type="text"/>					
Reinforcing (Tick if required)							
4mm Mdf <input type="checkbox"/>		Aluminium <input type="checkbox"/>		9mm Mdf <input type="checkbox"/>		Solid Mdf <input type="checkbox"/>	
Cut to size (if required)							
Width _____ mm x (Height _____ mm)							
Min Cut : Width 520mm Height:1575mm							
Glass Design Required: _____							
Backing Glass Pattern: _____							
Spacer Bar Colour: _____							
Silver Spacer Bar as standard subject to design							
Accessories (Tick extras required)							
<i>N.B. Letter PLate fitted in midrail as standard. Moved to bottom if knocker supplied</i>							
	Urn Knocker	Urn with Spy	Lions Head	Spy Hole	Slim Urn	Slim Urn with Spy	Letter Plate
Gold	<input type="checkbox"/>	<input type="checkbox"/>	Not Available	Not Available	<input type="checkbox"/>	<input type="checkbox"/>	<input type="checkbox"/>
Brass	<input type="checkbox"/>	<input type="checkbox"/>	<input type="checkbox"/>	<input type="checkbox"/>	Not Available	Not Available	Not Available
Black	<input type="checkbox"/>	<input type="checkbox"/>	<input type="checkbox"/>	Not Available	<input type="checkbox"/>	<input type="checkbox"/>	<input type="checkbox"/>
White	<input type="checkbox"/>	<input type="checkbox"/>	<input type="checkbox"/>	Not Available	<input type="checkbox"/>	<input type="checkbox"/>	<input type="checkbox"/>
Chrome	<input type="checkbox"/>	<input type="checkbox"/>	Not Available	<input type="checkbox"/>	Not Available	Not Available	<input type="checkbox"/>
Silver	<input type="checkbox"/>	<input type="checkbox"/>	Not Available	Not Available	Not Available	Not Available	<input type="checkbox"/>
<i>(Certain accessories not applicable with glazed options)</i>							

Special Instructions if required:

CUSTOMER SPECIFICATION

ORDER FORM

<i>ROUTE</i>		
<i>Invoice Address:</i>	<i>Delivery Address:</i>	
	<i>Date Required:</i> / /	
<i>Order No:</i>	<i>Ref:</i>	
<i>Date:</i> / /	<i>Contact:</i>	

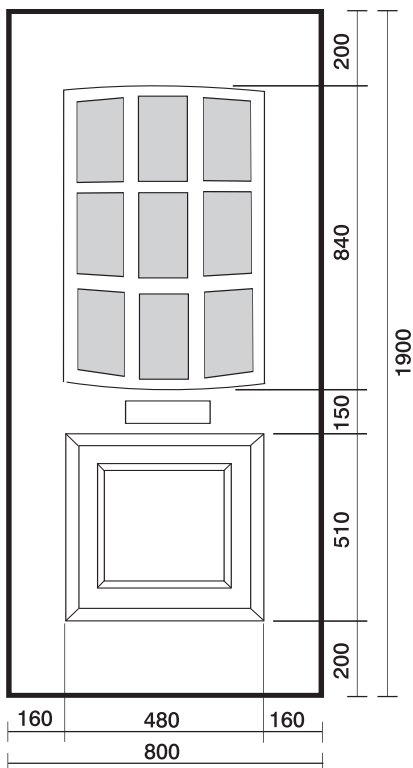

SHADED AREA INDICATES GLAZING AREAS

FAX SALES LINE

**01482
701185**

**PHOTOCOPY THIS SHEET
BEFORE COMPLETING &
FAXING WITH YOUR
OFFICIAL ORDER**

Door: *BURNBY GLAZED*

Door Panel Colour/Profile _____

Door Panel Thickness: mm *Door Panel Quantity:*

Reinforcing (Tick if required)
 4mm Mdf Aluminium 9mm Mdf Solid Mdf

Cut to size (if required)
 Width _____ mm) x (Height _____ mm)
 Min Cut : Width 530mm Height:1550mm

Backing Glass Pattern: _____

Spacer Bar Colour: _____
 Silver Spacer Bar as standard subject to design

Accessories (Tick extras required)

N.B. Letter PLate fitted in midrail as standard. Moved to bottom if knocker supplied

	<i>Urn Knocker</i>	<i>Urn with Spy</i>	<i>Lions Head</i>	<i>Spy Hole</i>	<i>Slim Urn</i>	<i>Slim Urn with Spy</i>	<i>Letter Plate</i>
<i>Gold</i>	<input type="checkbox"/>	<input type="checkbox"/>	<i>Not Available</i>	<i>Not Available</i>	<input type="checkbox"/>	<input type="checkbox"/>	<input type="checkbox"/>
<i>Brass</i>	<input type="checkbox"/>	<input type="checkbox"/>	<input type="checkbox"/>	<input type="checkbox"/>	<i>Not Available</i>	<i>Not Available</i>	<i>Not Available</i>
<i>Black</i>	<input type="checkbox"/>	<input type="checkbox"/>	<input type="checkbox"/>	<i>Not Available</i>	<input type="checkbox"/>	<input type="checkbox"/>	<input type="checkbox"/>
<i>White</i>	<input type="checkbox"/>	<input type="checkbox"/>	<input type="checkbox"/>	<i>Not Available</i>	<input type="checkbox"/>	<input type="checkbox"/>	<input type="checkbox"/>
<i>Chrome</i>	<input type="checkbox"/>	<input type="checkbox"/>	<i>Not Available</i>	<input type="checkbox"/>	<i>Not Available</i>	<i>Not Available</i>	<input type="checkbox"/>
<i>Silver</i>	<input type="checkbox"/>	<input type="checkbox"/>	<i>Not Available</i>	<i>Not Available</i>	<i>Not Available</i>	<i>Not Available</i>	<input type="checkbox"/>

(Certain accessories not applicable with glazed options)

Special Instructions if required:

**HALLMARK
PANELS LIMITED**

Valletta House, Valletta Street, Hedon Road, Hull. HU9 5NP
 Customer Service: +44 (0)1482 703222, Fax: +44 (0)1482 701185, Reception: +44 (0)1482 781111

All dimensions are approximate and within manufacturing tolerances of +/-3mm. However, due to our policy of continuous development, we reserve the right to change specifications without notice

CUSTOMER SPECIFICATION

ORDER FORM

ROUTE		
Invoice Address:	Delivery Address:	
	Date Required: / /	
Order No:	Ref:	
Date: / /	Contact:	

All panels will be manufactured to our standard size Carlton unless otherwise stated.

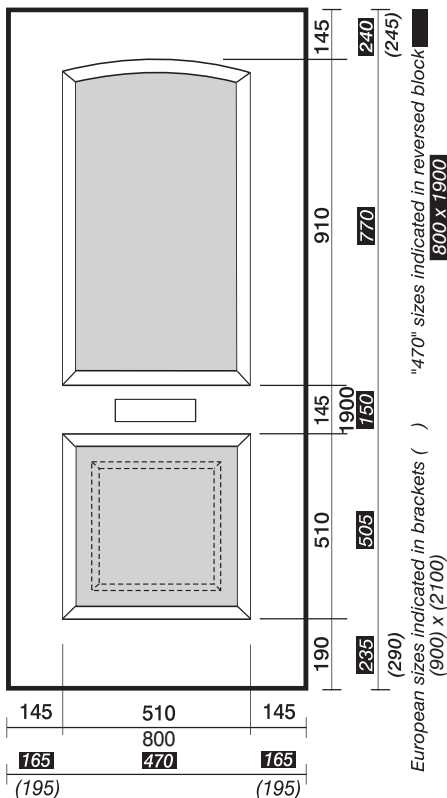

SHADED AREA INDICATES GLAZING AREAS

FAX SALES LINE

**01482
701185**

**PHOTOCOPY THIS SHEET
BEFORE COMPLETING &
FAXING WITH YOUR
OFFICIAL ORDER**

Door: CARLTON <input type="checkbox"/> CARLTON <input type="checkbox"/> CARLTON <input type="checkbox"/> CLASSIC "470" EURO																																																									
Panel Type: Solid <input type="checkbox"/> One <input type="checkbox"/> Two <input type="checkbox"/>																																																									
Door Panel Colour/Profile _____																																																									
Door Panel Thickness: <input type="text"/> mm	Door Panel Quantity: <input type="text"/>																																																								
Reinforcing (Tick if required) 4mm Mdf <input type="checkbox"/> Aluminium <input type="checkbox"/> 9mm Mdf <input type="checkbox"/> Solid Mdf <input type="checkbox"/>																																																									
Cut to size (if required) Width _____ mm x (Height _____ mm) Min Cut : Standard W: 560mm H: 1615mm 470 W: 520mm H: 1475mm																																																									
Glass Design Required: _____																																																									
Backing Glass Pattern: _____																																																									
Spacer Bar Colour: _____ Silver Spacer Bar as standard subject to design																																																									
Accessories (Tick extras required)																																																									
<i>N.B. Letter PLate fitted in midrail as standard. Moved to bottom if knocker supplied</i>																																																									
	<table border="1" style="width: 100%; border-collapse: collapse; font-size: small;"> <thead> <tr> <th></th> <th>Urn Knocker</th> <th>Urn with Spy</th> <th>Lions Head</th> <th>Spy Hole</th> <th>Slim Urn</th> <th>Slim Urn with Spy</th> <th>Letter Plate</th> </tr> </thead> <tbody> <tr> <td>Gold</td> <td style="text-align: center;"><input type="checkbox"/></td> <td style="text-align: center;"><input type="checkbox"/></td> <td style="text-align: center;">Not Available</td> <td style="text-align: center;">Not Available</td> <td style="text-align: center;"><input type="checkbox"/></td> <td style="text-align: center;"><input type="checkbox"/></td> <td style="text-align: center;"><input type="checkbox"/></td> </tr> <tr> <td>Brass</td> <td style="text-align: center;"><input type="checkbox"/></td> <td style="text-align: center;"><input type="checkbox"/></td> <td style="text-align: center;"><input type="checkbox"/></td> <td style="text-align: center;"><input type="checkbox"/></td> <td style="text-align: center;">Not Available</td> <td style="text-align: center;">Not Available</td> <td style="text-align: center;">Not Available</td> </tr> <tr> <td>Black</td> <td style="text-align: center;"><input type="checkbox"/></td> <td style="text-align: center;"><input type="checkbox"/></td> <td style="text-align: center;"><input type="checkbox"/></td> <td style="text-align: center;">Not Available</td> <td style="text-align: center;"><input type="checkbox"/></td> <td style="text-align: center;"><input type="checkbox"/></td> <td style="text-align: center;"><input type="checkbox"/></td> </tr> <tr> <td>White</td> <td style="text-align: center;"><input type="checkbox"/></td> <td style="text-align: center;"><input type="checkbox"/></td> <td style="text-align: center;"><input type="checkbox"/></td> <td style="text-align: center;">Not Available</td> <td style="text-align: center;"><input type="checkbox"/></td> <td style="text-align: center;"><input type="checkbox"/></td> <td style="text-align: center;"><input type="checkbox"/></td> </tr> <tr> <td>Chrome</td> <td style="text-align: center;"><input type="checkbox"/></td> <td style="text-align: center;"><input type="checkbox"/></td> <td style="text-align: center;">Not Available</td> <td style="text-align: center;"><input type="checkbox"/></td> <td style="text-align: center;">Not Available</td> <td style="text-align: center;">Not Available</td> <td style="text-align: center;"><input type="checkbox"/></td> </tr> <tr> <td>Silver</td> <td style="text-align: center;"><input type="checkbox"/></td> <td style="text-align: center;"><input type="checkbox"/></td> <td style="text-align: center;">Not Available</td> <td style="text-align: center;">Not Available</td> <td style="text-align: center;">Not Available</td> <td style="text-align: center;">Not Available</td> <td style="text-align: center;"><input type="checkbox"/></td> </tr> </tbody> </table>		Urn Knocker	Urn with Spy	Lions Head	Spy Hole	Slim Urn	Slim Urn with Spy	Letter Plate	Gold	<input type="checkbox"/>	<input type="checkbox"/>	Not Available	Not Available	<input type="checkbox"/>	<input type="checkbox"/>	<input type="checkbox"/>	Brass	<input type="checkbox"/>	<input type="checkbox"/>	<input type="checkbox"/>	<input type="checkbox"/>	Not Available	Not Available	Not Available	Black	<input type="checkbox"/>	<input type="checkbox"/>	<input type="checkbox"/>	Not Available	<input type="checkbox"/>	<input type="checkbox"/>	<input type="checkbox"/>	White	<input type="checkbox"/>	<input type="checkbox"/>	<input type="checkbox"/>	Not Available	<input type="checkbox"/>	<input type="checkbox"/>	<input type="checkbox"/>	Chrome	<input type="checkbox"/>	<input type="checkbox"/>	Not Available	<input type="checkbox"/>	Not Available	Not Available	<input type="checkbox"/>	Silver	<input type="checkbox"/>	<input type="checkbox"/>	Not Available	Not Available	Not Available	Not Available	<input type="checkbox"/>
	Urn Knocker	Urn with Spy	Lions Head	Spy Hole	Slim Urn	Slim Urn with Spy	Letter Plate																																																		
Gold	<input type="checkbox"/>	<input type="checkbox"/>	Not Available	Not Available	<input type="checkbox"/>	<input type="checkbox"/>	<input type="checkbox"/>																																																		
Brass	<input type="checkbox"/>	<input type="checkbox"/>	<input type="checkbox"/>	<input type="checkbox"/>	Not Available	Not Available	Not Available																																																		
Black	<input type="checkbox"/>	<input type="checkbox"/>	<input type="checkbox"/>	Not Available	<input type="checkbox"/>	<input type="checkbox"/>	<input type="checkbox"/>																																																		
White	<input type="checkbox"/>	<input type="checkbox"/>	<input type="checkbox"/>	Not Available	<input type="checkbox"/>	<input type="checkbox"/>	<input type="checkbox"/>																																																		
Chrome	<input type="checkbox"/>	<input type="checkbox"/>	Not Available	<input type="checkbox"/>	Not Available	Not Available	<input type="checkbox"/>																																																		
Silver	<input type="checkbox"/>	<input type="checkbox"/>	Not Available	Not Available	Not Available	Not Available	<input type="checkbox"/>																																																		
<i>(Certain accessories not applicable with glazed options)</i>																																																									

Special Instructions if required: Euro 470 not available

CUSTOMER SPECIFICATION

ORDER FORM

<i>ROUTE</i>	
<i>Invoice Address:</i>	<i>Delivery Address:</i>
<i>Order No:</i>	<i>Date Required:</i> / /
<i>Date:</i> / /	<i>Ref:</i>
<i>Date:</i> / /	<i>Contact:</i>

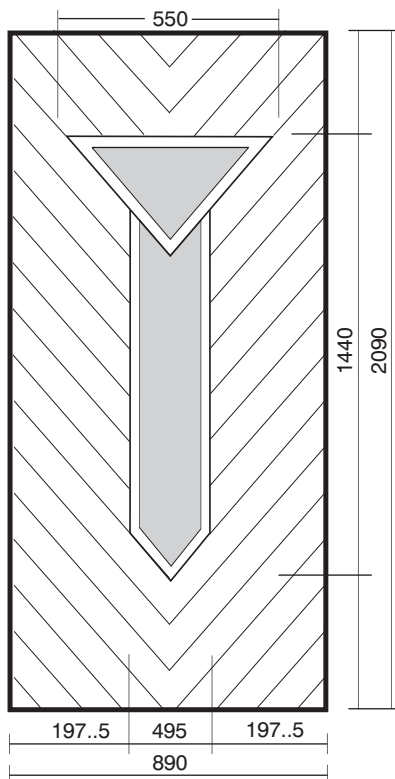

SHADED AREA INDICATES GLAZING AREAS

FAX SALES LINE

01482
701185

PHOTOCOPY THIS SHEET
BEFORE COMPLETING &
FAXING WITH YOUR
OFFICIAL ORDER

<i>Door:</i> CATTON	
<i>Panel Type:</i> Solid <input type="checkbox"/> One <input type="checkbox"/> Two <input type="checkbox"/>	
<i>Door Panel Colour/Profile</i> _____	
<i>Door Panel Thickness:</i> <input type="text"/> mm	<i>Door Panel Quantity:</i> <input type="text"/>
<i>Reinforcing (Tick if required)</i> <i>Other options not available on this style</i>	
4mm Mdf <input type="checkbox"/> Aluminium <input type="checkbox"/>	
<i>Cut to size (if required)</i>	
Width _____ mm) x (Height _____ mm)	
Min Cut : Width 600mm Height:1550mm	
<i>Backing Glass Pattern:</i> _____	
<i>Spacer Bar Colour:</i> _____	
<i>Silver Spacer Bar as standard subject to design</i>	
Accessories	
<i>Accessories not supplied fitted on this design - can be supplied loose if requested.</i>	

Special Instructions if required:

HALLMARK
PANELS LIMITED

Valletta House, Valletta Street, Hedon Road, Hull. HU9 5NP
Customer Service: +44 (0)1482 703222, Fax: +44 (0)1482 701185, Reception: +44 (0)1482 781111

All dimensions are approximate and within manufacturing tolerances of +/-3mm. However, due to our policy of continuous development, we reserve the right to change specifications without notice

CUSTOMER SPECIFICATION

ORDER FORM

<i>ROUTE</i>		
<i>Invoice Address:</i>	<i>Delivery Address:</i>	
	<i>Date Required:</i> / /	
<i>Order No:</i>	<i>Ref:</i>	
<i>Date:</i> / /	<i>Contact:</i>	

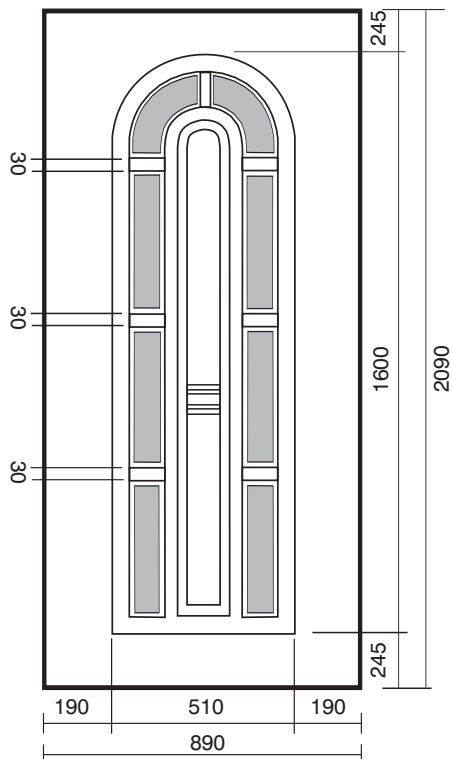

SHADED AREA INDICATES GLAZING AREAS

FAX SALES LINE

01482

701185

PHOTOCOPY THIS SHEET
BEFORE COMPLETING &
FAXING WITH YOUR
OFFICIAL ORDER

<i>Door:</i> CHAMBORD	
<i>Panel Type:</i> Solid <input type="checkbox"/> Two <input type="checkbox"/> Eight <input type="checkbox"/>	
<i>Door Panel Colour/Profile:</i> _____	
<i>Door Panel Thickness:</i> <input type="text"/> mm	<i>Door Panel Quantity:</i> <input type="text"/>
<i>Reinforcing (Tick if required)</i>	
4mm Mdf <input type="checkbox"/> Aluminium <input type="checkbox"/> 9mm Mdf <input type="checkbox"/> Solid Mdf <input type="checkbox"/>	
<i>Cut to size (if required)</i>	
Width _____ mm) x (Height _____ mm)	
Min Cut : Width 560mm Height:1650mm	
<i>Glass Design Required:</i> _____	
<i>Backing Glass Pattern:</i> _____	
<i>Spacer Bar Colour:</i> _____	
Silver Spacer Bar as standard subject to design	
Accessories	
Accessories not supplied fitted on this design - can be supplied loose if requested.	

Special Instructions if required:

CUSTOMER SPECIFICATION

ORDER FORM

ROUTE	
Invoice Address:	Delivery Address:
	Date Required: / /
Order No:	Ref:
Date: / /	Contact:

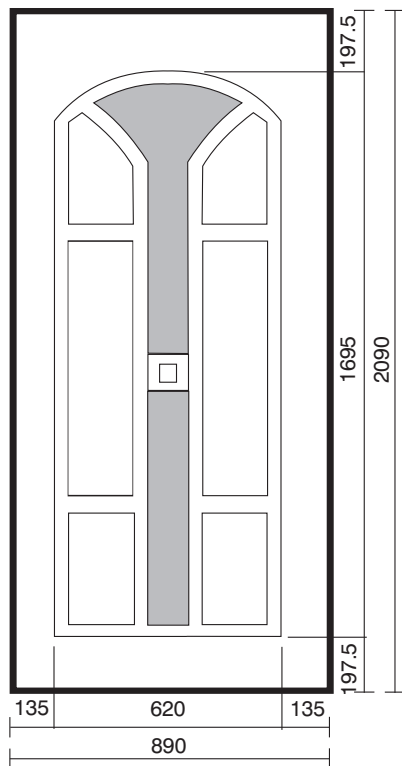

SHADED AREA INDICATES GLAZING AREAS

FAX SALES LINE

01482 701185

PHOTOCOPY THIS SHEET BEFORE COMPLETING & FAXING WITH YOUR OFFICIAL ORDER

Door: CHANTILLY
Panel Type: Solid <input type="checkbox"/> One <input type="checkbox"/> Two <input type="checkbox"/>
Door Panel Colour/Profile _____
Door Panel Thickness: <input type="text"/> mm Door Panel Quantity: <input type="text"/>
Reinforcing (Tick if required) 4mm Mdf <input type="checkbox"/> Aluminium <input type="checkbox"/> 9mm Mdf <input type="checkbox"/> Solid Mdf <input type="checkbox"/>
Cut to size (if required) Width _____ mm x (Height _____ mm) Min Cut : Width 670mm Height:1745mm
Glass Design Required: _____
Backing Glass Pattern: _____
Spacer Bar Colour: _____ Silver Spacer Bar as standard subject to design
Accessories
Accessories not supplied fitted on this design - can be supplied loose if requested.
(Certain accessories not applicable with glazed options)

Special Instructions if required:

HALLMARK
PANELS LIMITED

Valletta House, Valletta Street, Hedon Road, Hull. HU9 5NP
Customer Service: +44 (0)1482 703222, Fax: +44 (0)1482 701185, Reception: +44 (0)1482 781111

All dimensions are approximate and within manufacturing tolerances of +/-3mm. However, due to our policy of continuous development, we reserve the right to change specifications without notice

CUSTOMER SPECIFICATION

ORDER FORM

ROUTE	
Invoice Address:	Delivery Address:
	Date Required: / /
Order No:	Ref:
Date: / /	Contact:

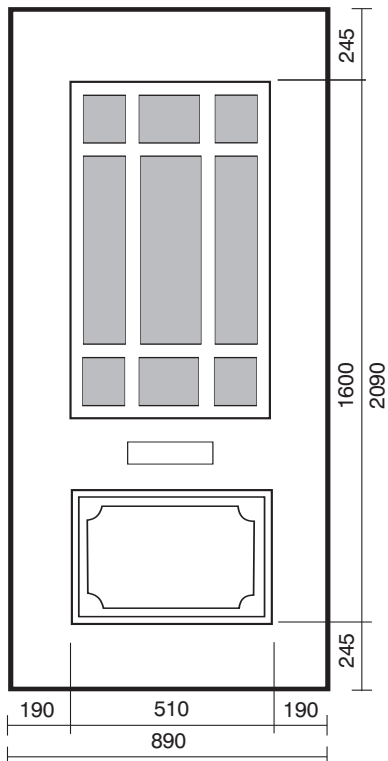

SHADED AREA INDICATES GLAZING AREAS

FAX SALES LINE

01482 701185

PHOTOCOPY THIS SHEET BEFORE COMPLETING & FAXING WITH YOUR OFFICIAL ORDER

Door: CHEVERNY														
Panel Type: Solid <input type="checkbox"/> One <input type="checkbox"/>														
Door Panel Colour/Profile _____														
Door Panel Thickness: <input type="text"/> mm Door Panel Quantity: <input type="text"/>														
Reinforcing (Tick if required) 4mm Mdf <input type="checkbox"/> Aluminium <input type="checkbox"/> 9mm Mdf <input type="checkbox"/> Solid Mdf <input type="checkbox"/>														
Cut to size (if required) Width _____ mm x (Height _____ mm) Min Cut : Width 560mm Height:1650mm														
Glass Design Required: _____														
Backing Glass Pattern: _____														
Spacer Bar Colour: _____ Silver Spacer Bar as standard subject to design														
Accessories (Tick extras required)														
<i>N.B. Letter PLate fitted in midrail as standard.</i>														
<table border="1"> <thead> <tr> <th></th> <th>Letter Plate</th> </tr> </thead> <tbody> <tr> <td>Gold</td> <td><input type="checkbox"/></td> </tr> <tr> <td>Brass</td> <td>Not Available</td> </tr> <tr> <td>Black</td> <td><input type="checkbox"/></td> </tr> <tr> <td>White</td> <td><input type="checkbox"/></td> </tr> <tr> <td>Chrome</td> <td><input type="checkbox"/></td> </tr> <tr> <td>Silver</td> <td><input type="checkbox"/></td> </tr> </tbody> </table>		Letter Plate	Gold	<input type="checkbox"/>	Brass	Not Available	Black	<input type="checkbox"/>	White	<input type="checkbox"/>	Chrome	<input type="checkbox"/>	Silver	<input type="checkbox"/>
	Letter Plate													
Gold	<input type="checkbox"/>													
Brass	Not Available													
Black	<input type="checkbox"/>													
White	<input type="checkbox"/>													
Chrome	<input type="checkbox"/>													
Silver	<input type="checkbox"/>													
All other accessories supplied loose if required														

Special Instructions if required:

CUSTOMER SPECIFICATION

ORDER FORM

ROUTE		
Invoice Address:	Delivery Address:	
	Date Required: / /	
Order No:	Ref:	
Date: / /	Contact:	

All panels will be manufactured to our standard size Elsham unless otherwise stated.

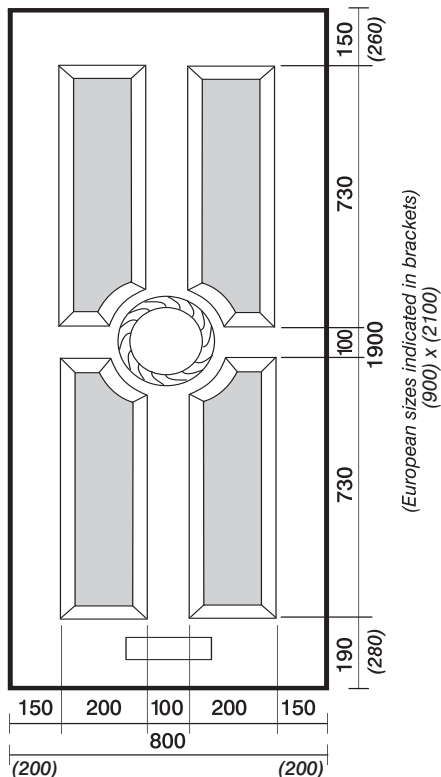

SHADED AREA INDICATES GLAZING AREAS

FAX SALES LINE

01482 701185

PHOTOCOPY THIS SHEET BEFORE COMPLETING & FAXING WITH YOUR OFFICIAL ORDER

Door: ELSHAM <input type="checkbox"/> ELSHAM EURO <input type="checkbox"/>																													
Panel Type: Solid <input type="checkbox"/> Two <input type="checkbox"/> Four <input type="checkbox"/>																													
Door Panel Colour/Profile _____																													
Door Panel Thickness: <input type="text"/> mm	Door Panel Quantity: <input type="text"/>																												
Reinforcing (Tick if required)																													
4mm Mdf <input type="checkbox"/> Aluminium <input type="checkbox"/> 9mm Mdf <input type="checkbox"/> Solid Mdf <input type="checkbox"/>																													
Cut to size (if required)																													
Width _____ mm) x (Height _____ mm)																													
Min Cut : Width 550mm Height:1610mm																													
Glass Design Required: _____																													
Backing Glass Pattern: _____																													
Spacer Bar Colour: _____																													
Silver Spacer Bar as standard subject to design																													
Accessories (Tick extras required)																													
<i>N.B. Letter PLate fitted in baserail as standard.</i>																													
	<table border="1" style="width: 100%; border-collapse: collapse;"> <thead> <tr> <th></th> <th style="text-align: center;">Lions Head</th> <th style="text-align: center;">Spy Hole</th> <th style="text-align: center;">Letter Plate</th> </tr> </thead> <tbody> <tr> <td style="text-align: center;">Gold</td> <td style="text-align: center;">Not Available</td> <td style="text-align: center;">Not Available</td> <td style="text-align: center;"><input type="checkbox"/></td> </tr> <tr> <td style="text-align: center;">Brass</td> <td style="text-align: center;"><input type="checkbox"/></td> <td style="text-align: center;"><input type="checkbox"/></td> <td style="text-align: center;">Not Available</td> </tr> <tr> <td style="text-align: center;">Black</td> <td style="text-align: center;"><input type="checkbox"/></td> <td style="text-align: center;">Not Available</td> <td style="text-align: center;"><input type="checkbox"/></td> </tr> <tr> <td style="text-align: center;">White</td> <td style="text-align: center;"><input type="checkbox"/></td> <td style="text-align: center;">Not Available</td> <td style="text-align: center;"><input type="checkbox"/></td> </tr> <tr> <td style="text-align: center;">Chrome</td> <td style="text-align: center;">Not Available</td> <td style="text-align: center;"><input type="checkbox"/></td> <td style="text-align: center;"><input type="checkbox"/></td> </tr> <tr> <td style="text-align: center;">Silver</td> <td style="text-align: center;">Not Available</td> <td style="text-align: center;">Not Available</td> <td style="text-align: center;"><input type="checkbox"/></td> </tr> </tbody> </table>		Lions Head	Spy Hole	Letter Plate	Gold	Not Available	Not Available	<input type="checkbox"/>	Brass	<input type="checkbox"/>	<input type="checkbox"/>	Not Available	Black	<input type="checkbox"/>	Not Available	<input type="checkbox"/>	White	<input type="checkbox"/>	Not Available	<input type="checkbox"/>	Chrome	Not Available	<input type="checkbox"/>	<input type="checkbox"/>	Silver	Not Available	Not Available	<input type="checkbox"/>
	Lions Head	Spy Hole	Letter Plate																										
Gold	Not Available	Not Available	<input type="checkbox"/>																										
Brass	<input type="checkbox"/>	<input type="checkbox"/>	Not Available																										
Black	<input type="checkbox"/>	Not Available	<input type="checkbox"/>																										
White	<input type="checkbox"/>	Not Available	<input type="checkbox"/>																										
Chrome	Not Available	<input type="checkbox"/>	<input type="checkbox"/>																										
Silver	Not Available	Not Available	<input type="checkbox"/>																										
<i>(Certain accessories not applicable with glazed options)</i>																													

Special Instructions if required:

**HALLMARK
PANELS LIMITED**

Valletta House, Valletta Street, Hedon Road, Hull. HU9 5NP
Customer Service: +44 (0)1482 703222, Fax: +44 (0)1482 701185, Reception: +44 (0)1482 781111

All dimensions are approximate and within manufacturing tolerances of +/-3mm. However, due to our policy of continuous development, we reserve the right to change specifications without notice

CUSTOMER SPECIFICATION

ORDER FORM

ROUTE	
Invoice Address:	Delivery Address:
Order No:	Date Required: / /
Date: / /	Ref:
	Contact:

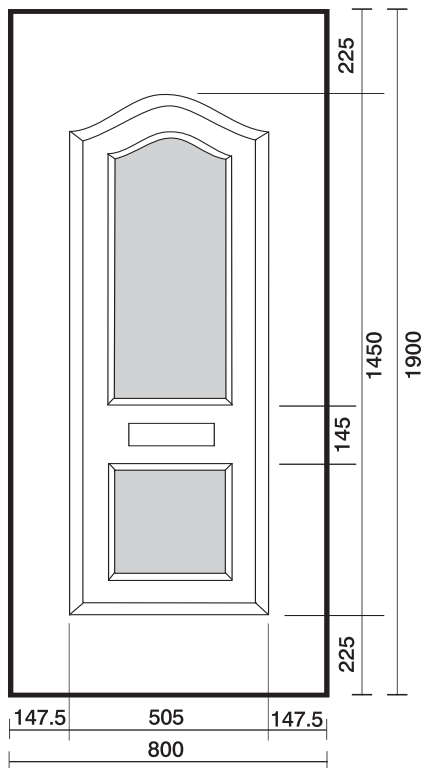

SHADED AREA INDICATES GLAZING AREAS

FAX SALES LINE

01482 701185

PHOTOCOPY THIS SHEET BEFORE COMPLETING & FAXING WITH YOUR OFFICIAL ORDER

Door: ELTON							
Panel Type: Solid <input type="checkbox"/> One <input type="checkbox"/> Two <input type="checkbox"/>							
Door Panel Colour/Profile _____							
Door Panel Thickness: <input type="text"/> mm				Door Panel Quantity: <input type="text"/>			
Reinforcing (Tick if required)							
4mm Mdf <input type="checkbox"/> Aluminium <input type="checkbox"/> 9mm Mdf <input type="checkbox"/> Solid Mdf <input type="checkbox"/>							
Cut to size (if required)							
Width _____ mm x (Height _____ mm)							
Min Cut : Width 555mm Height:1500mm							
Glass Design Required: _____							
Backing Glass Pattern: _____							
Spacer Bar Colour: _____							
Silver Spacer Bar as standard subject to design							
Accessories (Tick extras required)							
N.B. Letter PLate fitted in midrail as standard. Moved to bottom if knocker supplied							
	Urn Knocker	Urn with Spy	Lions Head	Spy Hole	Slim Um	Slim Urn with Spy	Letter Plate
Gold	<input type="checkbox"/>	<input type="checkbox"/>	Not Available	Not Available	<input type="checkbox"/>	<input type="checkbox"/>	<input type="checkbox"/>
Brass	<input type="checkbox"/>	<input type="checkbox"/>	<input type="checkbox"/>	<input type="checkbox"/>	Not Available	Not Available	Not Available
Black	<input type="checkbox"/>	<input type="checkbox"/>	<input type="checkbox"/>	Not Available	<input type="checkbox"/>	<input type="checkbox"/>	<input type="checkbox"/>
White	<input type="checkbox"/>	<input type="checkbox"/>	<input type="checkbox"/>	Not Available	<input type="checkbox"/>	<input type="checkbox"/>	<input type="checkbox"/>
Chrome	<input type="checkbox"/>	<input type="checkbox"/>	Not Available	<input type="checkbox"/>	Not Available	Not Available	<input type="checkbox"/>
Silver	<input type="checkbox"/>	<input type="checkbox"/>	Not Available	Not Available	Not Available	Not Available	<input type="checkbox"/>
(Certain accessories not applicable with glazed options)							

Special Instructions if required:

CUSTOMER SPECIFICATION

ORDER FORM

ROUTE	
Invoice Address:	Delivery Address:
	Date Required: / /
Order No:	Ref:
Date: / /	Contact:

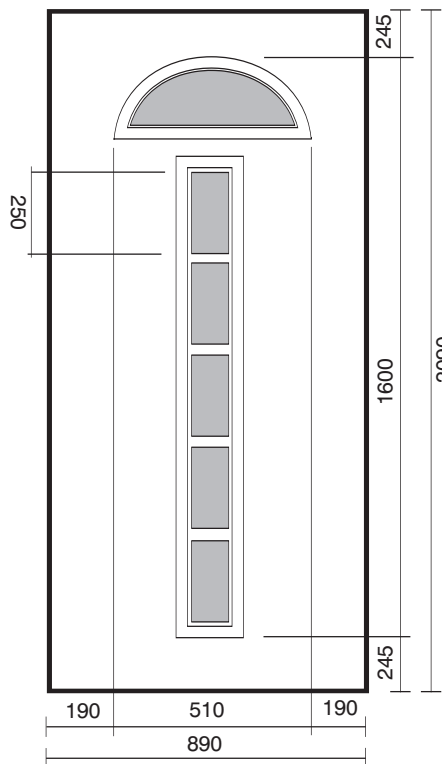

SHADED AREA INDICATES GLAZING AREAS

FAX SALES LINE
01482
701185

PHOTOCOPY THIS SHEET
 BEFORE COMPLETING &
 FAXING WITH YOUR
 OFFICIAL ORDER

Door: ELTZ
Panel Type: Solid <input type="checkbox"/> One <input type="checkbox"/> Two <input type="checkbox"/>
Door Panel Colour/Profile _____
Door Panel Thickness: <input type="text"/> mm Door Panel Quantity: <input type="text"/>
Reinforcing (Tick if required) 4mm Mdf <input type="checkbox"/> Aluminium <input type="checkbox"/> 9mm Mdf <input type="checkbox"/> Solid Mdf <input type="checkbox"/>
Cut to size (if required) Width _____ mm) x (Height _____ mm) Min Cut : Width 560mm Height:1650mm
Glass Design Required: _____
Backing Glass Pattern: _____
Spacer Bar Colour: _____ Silver Spacer Bar as standard subject to design
Accessories
Accessories not supplied fitted on this design - can be supplied loose if requested.
(Certain accessories not applicable with glazed options)

Special Instructions if required:

HALLMARK
PANELS LIMITED

Valletta House, Valletta Street, Hedon Road, Hull. HU9 5NP
 Customer Service: +44 (0)1482 703222, Fax: +44 (0)1482 701185, Reception: +44 (0)1482 781111

All dimensions are approximate and within manufacturing tolerances of +/-3mm. However, due to our policy of continuous development, we reserve the right to change specifications without notice

CUSTOMER SPECIFICATION

ORDER FORM

ROUTE		
Invoice Address:	Delivery Address:	
	Date Required: / /	
Order No:	Ref:	
Date: / /	Contact:	

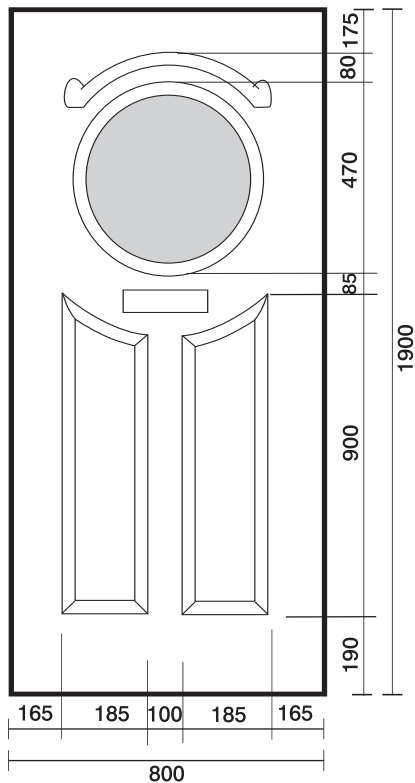

SHADED AREA INDICATES GLAZING AREAS

FAX SALES LINE

**01482
701185**

**PHOTOCOPY THIS SHEET
BEFORE COMPLETING &
FAXING WITH YOUR
OFFICIAL ORDER**

Door: GOODWOOD							
Panel Type: Solid <input type="checkbox"/> One <input type="checkbox"/>							
Door Panel Colour/Profile _____							
Door Panel Thickness: <input type="text"/> mm				Door Panel Quantity: <input type="text"/>			
Reinforcing (Tick if required)							
4mm Mdf <input type="checkbox"/>		Aluminium <input type="checkbox"/>		9mm Mdf <input type="checkbox"/>		Solid Mdf <input type="checkbox"/>	
Cut to size (if required)							
Width _____ mm x (Height _____ mm)							
Min Cut : Width 520mm Height:1585mm							
Glass Design Required: _____							
Backing Glass Pattern: _____							
Spacer Bar Colour: _____							
Silver Spacer Bar as standard subject to design							
Accessories (Tick extras required)							
<i>N.B. Letter PLate fitted in midrail as standard. Moved to bottom if knocker supplied</i>							
	Urn Knocker	Urn with Spy	Lions Head	Spy Hole	Slim Um	Slim Urn with Spy	Letter Plate
Gold	<input type="checkbox"/>	<input type="checkbox"/>	Not Available	Not Available	<input type="checkbox"/>	<input type="checkbox"/>	<input type="checkbox"/>
Brass	<input type="checkbox"/>	<input type="checkbox"/>	<input type="checkbox"/>	<input type="checkbox"/>	Not Available	Not Available	Not Available
Black	<input type="checkbox"/>	<input type="checkbox"/>	<input type="checkbox"/>	Not Available	<input type="checkbox"/>	<input type="checkbox"/>	<input type="checkbox"/>
White	<input type="checkbox"/>	<input type="checkbox"/>	<input type="checkbox"/>	Not Available	<input type="checkbox"/>	<input type="checkbox"/>	<input type="checkbox"/>
Chrome	<input type="checkbox"/>	<input type="checkbox"/>	Not Available	<input type="checkbox"/>	Not Available	Not Available	<input type="checkbox"/>
Silver	<input type="checkbox"/>	<input type="checkbox"/>	Not Available	Not Available	Not Available	Not Available	<input type="checkbox"/>
(Certain accessories not applicable with glazed options)							

Special Instructions if required:

CUSTOMER SPECIFICATION

ORDER FORM

ROUTE		
Invoice Address:	Delivery Address:	
	Date Required: / /	
Order No:	Ref:	
Date: / /	Contact:	

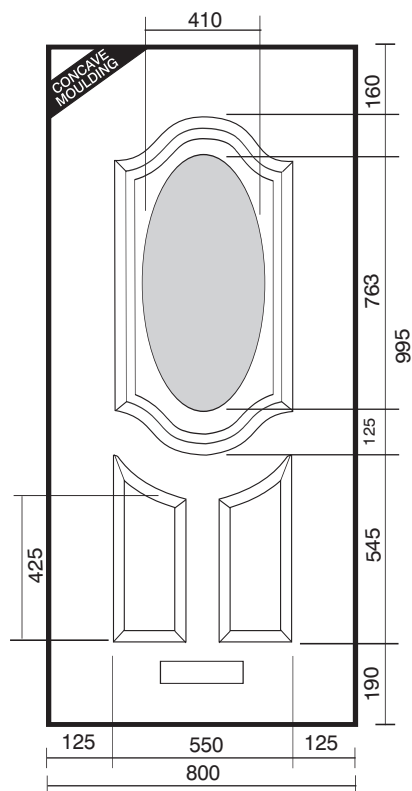

SHADED AREA INDICATES GLAZING AREAS

FAX SALES LINE

01482

701185

**PHOTOCOPY THIS SHEET
BEFORE COMPLETING &
FAXING WITH YOUR
OFFICIAL ORDER**

Door: GOSFIELD																																																								
Panel Type: Solid <input type="checkbox"/> One <input type="checkbox"/>																																																								
Door Panel Colour/Profile _____																																																								
Door Panel Thickness: <input type="text"/> mm Door Panel Quantity: <input type="text"/>																																																								
Reinforcing with 4mm MDF as standard																																																								
Cut to size (if required) Width _____ mm x (Height _____ mm) Min Cut : Width 600mm Height:1715mm																																																								
Glass Design Required: _____																																																								
Backing Glass Pattern: _____																																																								
Spacer Bar Colour: _____ Silver Spacer Bar as standard subject to design																																																								
Accessories (Tick extras required)																																																								
<i>N.B. Letter PLate fitted in baserail as standard.</i>																																																								
<table border="1" style="width: 100%; border-collapse: collapse; text-align: center;"> <thead> <tr> <th></th> <th>Urn Knocker</th> <th>Urn with Spy</th> <th>Lions Head</th> <th>Spy Hole</th> <th>Slim Um</th> <th>Slim Urn with Spy</th> <th>Letter Plate</th> </tr> </thead> <tbody> <tr> <td>Gold</td> <td><input type="checkbox"/></td> <td><input type="checkbox"/></td> <td>Not Available</td> <td>Not Available</td> <td><input type="checkbox"/></td> <td><input type="checkbox"/></td> <td><input type="checkbox"/></td> </tr> <tr> <td>Brass</td> <td><input type="checkbox"/></td> <td><input type="checkbox"/></td> <td><input type="checkbox"/></td> <td><input type="checkbox"/></td> <td>Not Available</td> <td>Not Available</td> <td>Not Available</td> </tr> <tr> <td>Black</td> <td><input type="checkbox"/></td> <td><input type="checkbox"/></td> <td><input type="checkbox"/></td> <td>Not Available</td> <td><input type="checkbox"/></td> <td><input type="checkbox"/></td> <td><input type="checkbox"/></td> </tr> <tr> <td>White</td> <td><input type="checkbox"/></td> <td><input type="checkbox"/></td> <td><input type="checkbox"/></td> <td>Not Available</td> <td><input type="checkbox"/></td> <td><input type="checkbox"/></td> <td><input type="checkbox"/></td> </tr> <tr> <td>Chrome</td> <td><input type="checkbox"/></td> <td><input type="checkbox"/></td> <td>Not Available</td> <td><input type="checkbox"/></td> <td>Not Available</td> <td>Not Available</td> <td><input type="checkbox"/></td> </tr> <tr> <td>Silver</td> <td><input type="checkbox"/></td> <td><input type="checkbox"/></td> <td>Not Available</td> <td>Not Available</td> <td>Not Available</td> <td>Not Available</td> <td><input type="checkbox"/></td> </tr> </tbody> </table>		Urn Knocker	Urn with Spy	Lions Head	Spy Hole	Slim Um	Slim Urn with Spy	Letter Plate	Gold	<input type="checkbox"/>	<input type="checkbox"/>	Not Available	Not Available	<input type="checkbox"/>	<input type="checkbox"/>	<input type="checkbox"/>	Brass	<input type="checkbox"/>	<input type="checkbox"/>	<input type="checkbox"/>	<input type="checkbox"/>	Not Available	Not Available	Not Available	Black	<input type="checkbox"/>	<input type="checkbox"/>	<input type="checkbox"/>	Not Available	<input type="checkbox"/>	<input type="checkbox"/>	<input type="checkbox"/>	White	<input type="checkbox"/>	<input type="checkbox"/>	<input type="checkbox"/>	Not Available	<input type="checkbox"/>	<input type="checkbox"/>	<input type="checkbox"/>	Chrome	<input type="checkbox"/>	<input type="checkbox"/>	Not Available	<input type="checkbox"/>	Not Available	Not Available	<input type="checkbox"/>	Silver	<input type="checkbox"/>	<input type="checkbox"/>	Not Available	Not Available	Not Available	Not Available	<input type="checkbox"/>
	Urn Knocker	Urn with Spy	Lions Head	Spy Hole	Slim Um	Slim Urn with Spy	Letter Plate																																																	
Gold	<input type="checkbox"/>	<input type="checkbox"/>	Not Available	Not Available	<input type="checkbox"/>	<input type="checkbox"/>	<input type="checkbox"/>																																																	
Brass	<input type="checkbox"/>	<input type="checkbox"/>	<input type="checkbox"/>	<input type="checkbox"/>	Not Available	Not Available	Not Available																																																	
Black	<input type="checkbox"/>	<input type="checkbox"/>	<input type="checkbox"/>	Not Available	<input type="checkbox"/>	<input type="checkbox"/>	<input type="checkbox"/>																																																	
White	<input type="checkbox"/>	<input type="checkbox"/>	<input type="checkbox"/>	Not Available	<input type="checkbox"/>	<input type="checkbox"/>	<input type="checkbox"/>																																																	
Chrome	<input type="checkbox"/>	<input type="checkbox"/>	Not Available	<input type="checkbox"/>	Not Available	Not Available	<input type="checkbox"/>																																																	
Silver	<input type="checkbox"/>	<input type="checkbox"/>	Not Available	Not Available	Not Available	Not Available	<input type="checkbox"/>																																																	
<i>(Certain accessories not applicable with glazed options)</i>																																																								

Special Instructions if required:

**HALLMARK
PANELS LIMITED**

Valletta House, Valletta Street, Hedon Road, Hull. HU9 5NP
Customer Service: +44 (0)1482 703222, Fax: +44 (0)1482 701185, Reception: +44 (0)1482 781111

All dimensions are approximate and within manufacturing tolerances of +/-3mm. However, due to our policy of continuous development, we reserve the right to change specifications without notice

CUSTOMER SPECIFICATION

ORDER FORM

ROUTE	
Invoice Address:	Delivery Address:
Order No:	Date Required: / /
Date: / /	Ref:
	Contact:

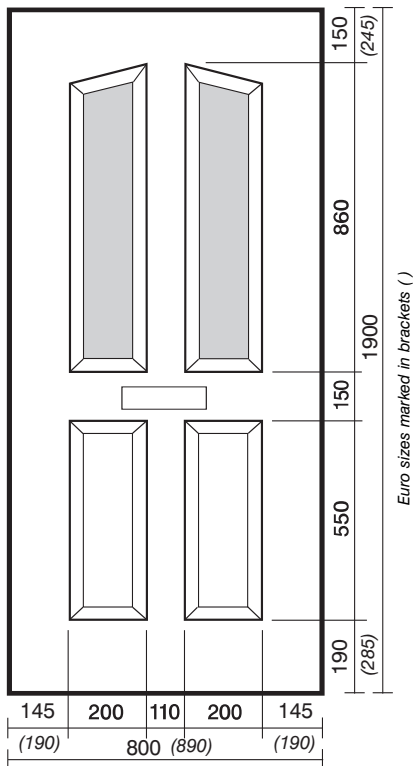

SHADED AREA INDICATES GLAZING AREAS

FAX SALES LINE

01482 701185

PHOTOCOPY THIS SHEET BEFORE COMPLETING & FAXING WITH YOUR OFFICIAL ORDER

Door: HAGLEY <input type="checkbox"/> HAGLEY EURO <input type="checkbox"/>																																																								
Panel Type: Solid <input type="checkbox"/> Two <input type="checkbox"/> Four <input type="checkbox"/>																																																								
Door Panel Colour/Profile _____																																																								
Door Panel Thickness: <input type="text"/> mm Door Panel Quantity: <input type="text"/>																																																								
Reinforcing (Tick if required) 4mm Mdf <input type="checkbox"/> Aluminium <input type="checkbox"/> 9mm Mdf <input type="checkbox"/> Solid Mdf <input type="checkbox"/>																																																								
Cut to size (if required) Width _____ mm x (Height _____ mm) Min Cut : Width 560mm Height:1610mm																																																								
Glass Design Required: _____																																																								
Backing Glass Pattern: _____																																																								
Spacer Bar Colour: _____ Silver Spacer Bar as standard subject to design																																																								
Accessories (Tick extras required) N.B. Letter PLate fitted in midrail as standard.																																																								
<table border="1"> <thead> <tr> <th></th> <th>Urn Knocker</th> <th>Urn with Spy</th> <th>Lions Head</th> <th>Spy Hole</th> <th>Slim Um</th> <th>Slim Urn with Spy</th> <th>Letter Plate</th> </tr> </thead> <tbody> <tr> <td>Gold</td> <td><input type="checkbox"/></td> <td><input type="checkbox"/></td> <td>Not Available</td> <td>Not Available</td> <td><input type="checkbox"/></td> <td><input type="checkbox"/></td> <td><input type="checkbox"/></td> </tr> <tr> <td>Brass</td> <td><input type="checkbox"/></td> <td><input type="checkbox"/></td> <td><input type="checkbox"/></td> <td><input type="checkbox"/></td> <td>Not Available</td> <td>Not Available</td> <td>Not Available</td> </tr> <tr> <td>Black</td> <td><input type="checkbox"/></td> <td><input type="checkbox"/></td> <td><input type="checkbox"/></td> <td>Not Available</td> <td><input type="checkbox"/></td> <td><input type="checkbox"/></td> <td><input type="checkbox"/></td> </tr> <tr> <td>White</td> <td><input type="checkbox"/></td> <td><input type="checkbox"/></td> <td><input type="checkbox"/></td> <td>Not Available</td> <td><input type="checkbox"/></td> <td><input type="checkbox"/></td> <td><input type="checkbox"/></td> </tr> <tr> <td>Chrome</td> <td><input type="checkbox"/></td> <td><input type="checkbox"/></td> <td>Not Available</td> <td><input type="checkbox"/></td> <td>Not Available</td> <td>Not Available</td> <td><input type="checkbox"/></td> </tr> <tr> <td>Silver</td> <td><input type="checkbox"/></td> <td><input type="checkbox"/></td> <td>Not Available</td> <td>Not Available</td> <td>Not Available</td> <td>Not Available</td> <td><input type="checkbox"/></td> </tr> </tbody> </table>		Urn Knocker	Urn with Spy	Lions Head	Spy Hole	Slim Um	Slim Urn with Spy	Letter Plate	Gold	<input type="checkbox"/>	<input type="checkbox"/>	Not Available	Not Available	<input type="checkbox"/>	<input type="checkbox"/>	<input type="checkbox"/>	Brass	<input type="checkbox"/>	<input type="checkbox"/>	<input type="checkbox"/>	<input type="checkbox"/>	Not Available	Not Available	Not Available	Black	<input type="checkbox"/>	<input type="checkbox"/>	<input type="checkbox"/>	Not Available	<input type="checkbox"/>	<input type="checkbox"/>	<input type="checkbox"/>	White	<input type="checkbox"/>	<input type="checkbox"/>	<input type="checkbox"/>	Not Available	<input type="checkbox"/>	<input type="checkbox"/>	<input type="checkbox"/>	Chrome	<input type="checkbox"/>	<input type="checkbox"/>	Not Available	<input type="checkbox"/>	Not Available	Not Available	<input type="checkbox"/>	Silver	<input type="checkbox"/>	<input type="checkbox"/>	Not Available	Not Available	Not Available	Not Available	<input type="checkbox"/>
	Urn Knocker	Urn with Spy	Lions Head	Spy Hole	Slim Um	Slim Urn with Spy	Letter Plate																																																	
Gold	<input type="checkbox"/>	<input type="checkbox"/>	Not Available	Not Available	<input type="checkbox"/>	<input type="checkbox"/>	<input type="checkbox"/>																																																	
Brass	<input type="checkbox"/>	<input type="checkbox"/>	<input type="checkbox"/>	<input type="checkbox"/>	Not Available	Not Available	Not Available																																																	
Black	<input type="checkbox"/>	<input type="checkbox"/>	<input type="checkbox"/>	Not Available	<input type="checkbox"/>	<input type="checkbox"/>	<input type="checkbox"/>																																																	
White	<input type="checkbox"/>	<input type="checkbox"/>	<input type="checkbox"/>	Not Available	<input type="checkbox"/>	<input type="checkbox"/>	<input type="checkbox"/>																																																	
Chrome	<input type="checkbox"/>	<input type="checkbox"/>	Not Available	<input type="checkbox"/>	Not Available	Not Available	<input type="checkbox"/>																																																	
Silver	<input type="checkbox"/>	<input type="checkbox"/>	Not Available	Not Available	Not Available	Not Available	<input type="checkbox"/>																																																	
(Certain accessories not applicable with glazed options)																																																								

Special Instructions if required:

CUSTOMER SPECIFICATION

ORDER FORM

ROUTE		
Invoice Address:	Delivery Address:	
	Date Required: / /	
Order No:	Ref:	
Date: / /	Contact:	

All panels will be manufactured to our standard size Hanbury unless otherwise stated.

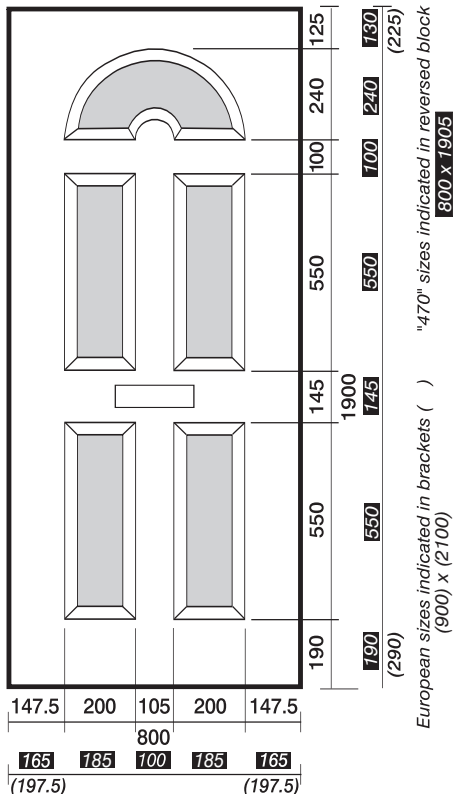

Door: HANBURY <input type="checkbox"/> HANBURY <input type="checkbox"/> HANBURY <input type="checkbox"/>	
"470"	
EURO	
Panel Type: Solid <input type="checkbox"/> One <input type="checkbox"/> Three <input type="checkbox"/> Five <input type="checkbox"/>	
Door Panel Colour/Profile _____	
Door Panel Thickness: <input type="text"/> mm	Door Panel Quantity: <input type="text"/>
Reinforcing (Tick if required)	
4mm Mdf <input type="checkbox"/> Aluminium <input type="checkbox"/> 9mm Mdf <input type="checkbox"/> Solid Mdf <input type="checkbox"/>	
Cut to size (if required)	
Width _____ mm x (Height _____ mm)	
MMin Cut : Standard W: 555mm H:1635mm 470 520mm H:1635mm	
Glass Design Required: _____	
Backing Glass Pattern: _____	
Spacer Bar Colour: _____	
Silver Spacer Bar as standard subject to design	

SHADED AREA INDICATES GLAZING AREAS

FAX SALES LINE

01482 701185

PHOTOCOPY THIS SHEET
BEFORE COMPLETING &
FAXING WITH YOUR
OFFICIAL ORDER

Accessories (Tick extras required)							
<small>N.B. Letter PLate fitted in midrail as standard.</small>							
	Urn Knocker	Urn with Spy	Lions Head	Spy Hole	Slim Urn	Slim Urn with Spy	Letter Plate
Gold	<input type="checkbox"/>	<input type="checkbox"/>	Not Available	Not Available	<input type="checkbox"/>	<input type="checkbox"/>	<input type="checkbox"/>
Brass	<input type="checkbox"/>	<input type="checkbox"/>	<input type="checkbox"/>	<input type="checkbox"/>	Not Available	Not Available	Not Available
Black	<input type="checkbox"/>	<input type="checkbox"/>	<input type="checkbox"/>	Not Available	<input type="checkbox"/>	<input type="checkbox"/>	<input type="checkbox"/>
White	<input type="checkbox"/>	<input type="checkbox"/>	<input type="checkbox"/>	Not Available	<input type="checkbox"/>	<input type="checkbox"/>	<input type="checkbox"/>
Chrome	<input type="checkbox"/>	<input type="checkbox"/>	Not Available	<input type="checkbox"/>	Not Available	Not Available	<input type="checkbox"/>
Silver	<input type="checkbox"/>	<input type="checkbox"/>	Not Available	Not Available	Not Available	Not Available	<input type="checkbox"/>

(Certain accessories not applicable with glazed options)

Special Instructions if required: Euro 470 not available

HALLMARK PANELS LIMITED

Valletta House, Valletta Street, Hedon Road, Hull. HU9 5NP
Customer Service: +44 (0)1482 703222, Fax: +44 (0)1482 701185, Reception: +44 (0)1482 781111

All dimensions are approximate and within manufacturing tolerances of +/-3mm. However, due to our policy of continuous development, we reserve the right to change specifications without notice

CUSTOMER SPECIFICATION

ORDER FORM

ROUTE		
Invoice Address:	Delivery Address:	
	Date Required: / /	
Order No:	Ref:	
Date: / /	Contact:	

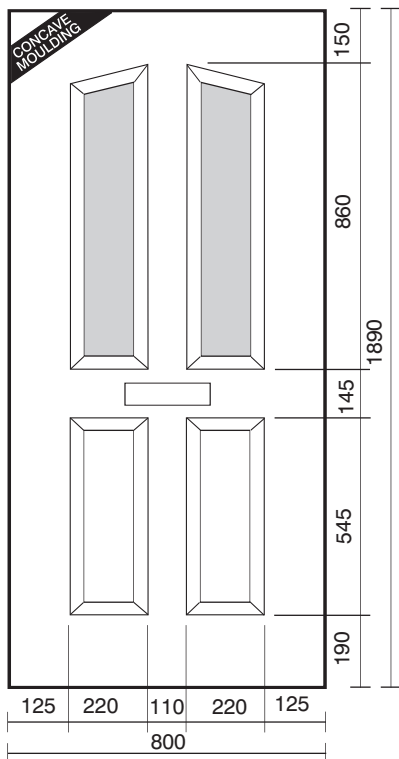

SHADED AREA INDICATES GLAZING AREAS

FAX SALES LINE

01482 701185

PHOTOCOPY THIS SHEET BEFORE COMPLETING & FAXING WITH YOUR OFFICIAL ORDER

Door: HARDFORD																																																								
Panel Type: Solid <input type="checkbox"/> Two <input type="checkbox"/>																																																								
Door Panel Colour/Profile _____																																																								
Door Panel Thickness: <input type="text"/> mm Door Panel Quantity: <input type="text"/>																																																								
Reinforcing with 4mm MDF as standard																																																								
Cut to size (if required) Width _____ mm x (Height _____ mm) Min Cut : Width 60mm Height:1600mm																																																								
Glass Design Required: _____																																																								
Backing Glass Pattern: _____																																																								
Spacer Bar Colour: _____ <i>Silver Spacer Bar as standard subject to design</i>																																																								
Accessories (Tick extras required)																																																								
<i>N.B. Letter PLate fitted in midrail as standard.</i>																																																								
<table border="1" style="width: 100%; border-collapse: collapse; text-align: center;"> <thead> <tr> <th></th> <th>Urn Knocker</th> <th>Urn with Spy</th> <th>Lions Head</th> <th>Spy Hole</th> <th>Slim Um</th> <th>Slim Urn with Spy</th> <th>Letter Plate</th> </tr> </thead> <tbody> <tr> <td>Gold</td> <td><input type="checkbox"/></td> <td><input type="checkbox"/></td> <td>Not Available</td> <td>Not Available</td> <td><input type="checkbox"/></td> <td><input type="checkbox"/></td> <td><input type="checkbox"/></td> </tr> <tr> <td>Brass</td> <td><input type="checkbox"/></td> <td><input type="checkbox"/></td> <td><input type="checkbox"/></td> <td><input type="checkbox"/></td> <td>Not Available</td> <td>Not Available</td> <td>Not Available</td> </tr> <tr> <td>Black</td> <td><input type="checkbox"/></td> <td><input type="checkbox"/></td> <td><input type="checkbox"/></td> <td>Not Available</td> <td><input type="checkbox"/></td> <td><input type="checkbox"/></td> <td><input type="checkbox"/></td> </tr> <tr> <td>White</td> <td><input type="checkbox"/></td> <td><input type="checkbox"/></td> <td><input type="checkbox"/></td> <td>Not Available</td> <td><input type="checkbox"/></td> <td><input type="checkbox"/></td> <td><input type="checkbox"/></td> </tr> <tr> <td>Chrome</td> <td><input type="checkbox"/></td> <td><input type="checkbox"/></td> <td>Not Available</td> <td><input type="checkbox"/></td> <td>Not Available</td> <td>Not Available</td> <td><input type="checkbox"/></td> </tr> <tr> <td>Silver</td> <td><input type="checkbox"/></td> <td><input type="checkbox"/></td> <td>Not Available</td> <td>Not Available</td> <td>Not Available</td> <td>Not Available</td> <td><input type="checkbox"/></td> </tr> </tbody> </table>		Urn Knocker	Urn with Spy	Lions Head	Spy Hole	Slim Um	Slim Urn with Spy	Letter Plate	Gold	<input type="checkbox"/>	<input type="checkbox"/>	Not Available	Not Available	<input type="checkbox"/>	<input type="checkbox"/>	<input type="checkbox"/>	Brass	<input type="checkbox"/>	<input type="checkbox"/>	<input type="checkbox"/>	<input type="checkbox"/>	Not Available	Not Available	Not Available	Black	<input type="checkbox"/>	<input type="checkbox"/>	<input type="checkbox"/>	Not Available	<input type="checkbox"/>	<input type="checkbox"/>	<input type="checkbox"/>	White	<input type="checkbox"/>	<input type="checkbox"/>	<input type="checkbox"/>	Not Available	<input type="checkbox"/>	<input type="checkbox"/>	<input type="checkbox"/>	Chrome	<input type="checkbox"/>	<input type="checkbox"/>	Not Available	<input type="checkbox"/>	Not Available	Not Available	<input type="checkbox"/>	Silver	<input type="checkbox"/>	<input type="checkbox"/>	Not Available	Not Available	Not Available	Not Available	<input type="checkbox"/>
	Urn Knocker	Urn with Spy	Lions Head	Spy Hole	Slim Um	Slim Urn with Spy	Letter Plate																																																	
Gold	<input type="checkbox"/>	<input type="checkbox"/>	Not Available	Not Available	<input type="checkbox"/>	<input type="checkbox"/>	<input type="checkbox"/>																																																	
Brass	<input type="checkbox"/>	<input type="checkbox"/>	<input type="checkbox"/>	<input type="checkbox"/>	Not Available	Not Available	Not Available																																																	
Black	<input type="checkbox"/>	<input type="checkbox"/>	<input type="checkbox"/>	Not Available	<input type="checkbox"/>	<input type="checkbox"/>	<input type="checkbox"/>																																																	
White	<input type="checkbox"/>	<input type="checkbox"/>	<input type="checkbox"/>	Not Available	<input type="checkbox"/>	<input type="checkbox"/>	<input type="checkbox"/>																																																	
Chrome	<input type="checkbox"/>	<input type="checkbox"/>	Not Available	<input type="checkbox"/>	Not Available	Not Available	<input type="checkbox"/>																																																	
Silver	<input type="checkbox"/>	<input type="checkbox"/>	Not Available	Not Available	Not Available	Not Available	<input type="checkbox"/>																																																	
<i>(Certain accessories not applicable with glazed options)</i>																																																								

Special Instructions if required:

CUSTOMER SPECIFICATION

ORDER FORM

ROUTE		
Invoice Address:	Delivery Address:	
	Date Required: / /	
Order No:	Ref:	
Date: / /	Contact:	

All panels will be manufactured to our standard size Heaton unless otherwise stated.

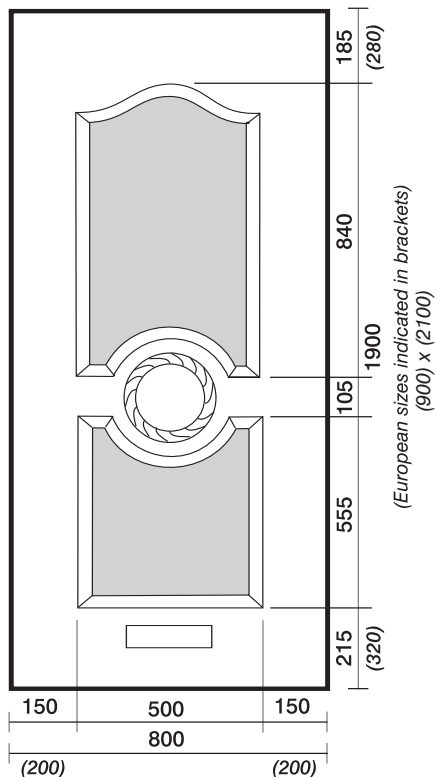

SHADED AREA INDICATES GLAZING AREAS

FAX SALES LINE

01482

701185

PHOTOCOPY THIS SHEET BEFORE COMPLETING & FAXING WITH YOUR OFFICIAL ORDER

Door: HEATON <input type="checkbox"/> HEATON EURO <input type="checkbox"/>																													
Panel Type: Solid <input type="checkbox"/> One <input type="checkbox"/> Two <input type="checkbox"/>																													
Door Panel Colour/Profile _____																													
Door Panel Thickness: <input type="text"/> mm	Door Panel Quantity: <input type="text"/>																												
Reinforcing (Tick if required)																													
4mm Mdf <input type="checkbox"/> Aluminium <input type="checkbox"/> 9mm Mdf <input type="checkbox"/> Solid Mdf <input type="checkbox"/>																													
Cut to size (if required)																													
Width _____ mm x (Height _____ mm)																													
Min Cut : Width 550mm Height:1550mm																													
Glass Design Required: _____																													
Backing Glass Pattern: _____																													
Spacer Bar Colour: _____																													
Silver Spacer Bar as standard subject to design																													
Accessories (Tick extras required)																													
<i>N.B. Letter PLate fitted in baserail as standard. Knocker supplied fitted in rope effect area</i>																													
	<table border="1" style="width: 100%; border-collapse: collapse;"> <thead> <tr> <th></th> <th style="text-align: center;">Lions Head</th> <th style="text-align: center;">Spy Hole</th> <th style="text-align: center;">Letter Plate</th> </tr> </thead> <tbody> <tr> <td style="text-align: center;">Gold</td> <td style="text-align: center;">Not Available</td> <td style="text-align: center;">Not Available</td> <td style="text-align: center;"><input type="checkbox"/></td> </tr> <tr> <td style="text-align: center;">Brass</td> <td style="text-align: center;"><input type="checkbox"/></td> <td style="text-align: center;"><input type="checkbox"/></td> <td style="text-align: center;">Not Available</td> </tr> <tr> <td style="text-align: center;">Black</td> <td style="text-align: center;"><input type="checkbox"/></td> <td style="text-align: center;">Not Available</td> <td style="text-align: center;"><input type="checkbox"/></td> </tr> <tr> <td style="text-align: center;">White</td> <td style="text-align: center;"><input type="checkbox"/></td> <td style="text-align: center;">Not Available</td> <td style="text-align: center;"><input type="checkbox"/></td> </tr> <tr> <td style="text-align: center;">Chrome</td> <td style="text-align: center;">Not Available</td> <td style="text-align: center;"><input type="checkbox"/></td> <td style="text-align: center;"><input type="checkbox"/></td> </tr> <tr> <td style="text-align: center;">Silver</td> <td style="text-align: center;">Not Available</td> <td style="text-align: center;">Not Available</td> <td style="text-align: center;"><input type="checkbox"/></td> </tr> </tbody> </table>		Lions Head	Spy Hole	Letter Plate	Gold	Not Available	Not Available	<input type="checkbox"/>	Brass	<input type="checkbox"/>	<input type="checkbox"/>	Not Available	Black	<input type="checkbox"/>	Not Available	<input type="checkbox"/>	White	<input type="checkbox"/>	Not Available	<input type="checkbox"/>	Chrome	Not Available	<input type="checkbox"/>	<input type="checkbox"/>	Silver	Not Available	Not Available	<input type="checkbox"/>
	Lions Head	Spy Hole	Letter Plate																										
Gold	Not Available	Not Available	<input type="checkbox"/>																										
Brass	<input type="checkbox"/>	<input type="checkbox"/>	Not Available																										
Black	<input type="checkbox"/>	Not Available	<input type="checkbox"/>																										
White	<input type="checkbox"/>	Not Available	<input type="checkbox"/>																										
Chrome	Not Available	<input type="checkbox"/>	<input type="checkbox"/>																										
Silver	Not Available	Not Available	<input type="checkbox"/>																										
<i>(Certain accessories not applicable with glazed options)</i>																													

Special Instructions if required:

HALLMARK
PANELS LIMITED

Valletta House, Valletta Street, Hedon Road, Hull. HU9 5NP
Customer Service: +44 (0)1482 703222, Fax: +44 (0)1482 701185, Reception: +44 (0)1482 781111

All dimensions are approximate and within manufacturing tolerances of +/-3mm. However, due to our policy of continuous development, we reserve the right to change specifications without notice

CUSTOMER SPECIFICATION

ORDER FORM

ROUTE	
Invoice Address:	Delivery Address:
Order No:	Date Required: / /
Date: / /	Ref:
	Contact:

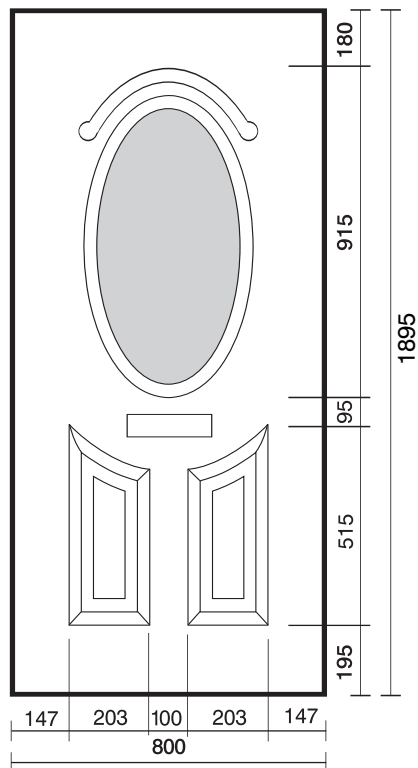

SHADED AREA INDICATES GLAZING AREAS

FAX SALES LINE

01482 701185

PHOTOCOPY THIS SHEET BEFORE COMPLETING & FAXING WITH YOUR OFFICIAL ORDER

Door: KENILWORTH							
Panel Type: Solid <input type="checkbox"/> One <input type="checkbox"/>							
Door Panel Colour/Profile _____							
Door Panel Thickness: <input type="text"/> mm	Door Panel Quantity: <input type="text"/>						
Reinforcing (Tick if required)							
4mm Mdf <input type="checkbox"/> Aluminium <input type="checkbox"/> 9mm Mdf <input type="checkbox"/> Solid Mdf <input type="checkbox"/>							
Cut to size (if required)							
Width _____ mm x (Height _____ mm)							
Min Cut : Width 556mm Height:1575mm							
Glass Design Required: _____							
Backing Glass Pattern: _____							
Spacer Bar Colour: _____							
Silver Spacer Bar as standard subject to design							
Accessories (Tick extras required)							
N.B. Letter PLate fitted in midrail as standard. Moved to bottom if knocker supplied							
	Urn Knocker	Urn with Spy	Lions Head	Spy Hole	Slim Um	Slim Urn with Spy	Letter Plate
Gold	<input type="checkbox"/>	<input type="checkbox"/>	Not Available	Not Available	<input type="checkbox"/>	<input type="checkbox"/>	<input type="checkbox"/>
Brass	<input type="checkbox"/>	<input type="checkbox"/>	<input type="checkbox"/>	<input type="checkbox"/>	Not Available	Not Available	Not Available
Black	<input type="checkbox"/>	<input type="checkbox"/>	<input type="checkbox"/>	Not Available	<input type="checkbox"/>	<input type="checkbox"/>	<input type="checkbox"/>
White	<input type="checkbox"/>	<input type="checkbox"/>	<input type="checkbox"/>	Not Available	<input type="checkbox"/>	<input type="checkbox"/>	<input type="checkbox"/>
Chrome	<input type="checkbox"/>	<input type="checkbox"/>	Not Available	<input type="checkbox"/>	Not Available	Not Available	<input type="checkbox"/>
Silver	<input type="checkbox"/>	<input type="checkbox"/>	Not Available	Not Available	Not Available	Not Available	<input type="checkbox"/>
(Certain accessories not applicable with glazed options)							

Special Instructions if required:

CUSTOMER SPECIFICATION

ORDER FORM

ROUTE		
Invoice Address:	Delivery Address:	
	Date Required: / /	
Order No:	Ref:	
Date: / /	Contact:	

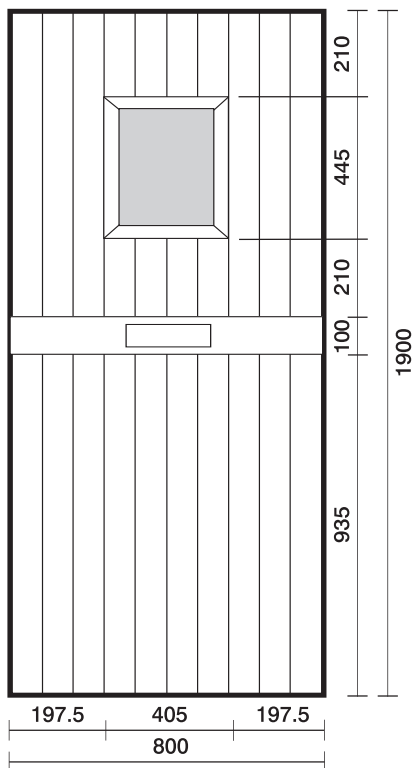

SHADED AREA INDICATES GLAZING AREAS

FAX SALES LINE

**01482
701185**

**PHOTOCOPY THIS SHEET
BEFORE COMPLETING &
FAXING WITH YOUR
OFFICIAL ORDER**

Door: KIRKLEY	
Panel Type: Solid <input type="checkbox"/> One <input type="checkbox"/>	
Door Panel Colour/Profile _____	
Door Panel Thickness: <input type="text"/> mm	Door Panel Quantity: <input type="text"/>
Reinforcing (Tick if required)	
4mm Mdf <input type="checkbox"/> Aluminium <input type="checkbox"/> 9mm Mdf <input type="checkbox"/> Solid Mdf <input type="checkbox"/>	
Cut to size (if required)	
Width _____ mm) x (Height _____ mm)	
Min Cut : Width 455mm Height:1550mm	
Glass Design Required: _____	
Backing Glass Pattern: _____	
Spacer Bar Colour: _____	
Silver Spacer Bar as standard subject to design	
Accessories (Tick extras required)	
<i>N.B. Letter Plate fitted in midrail as standard.</i>	
	Letter Plate
Gold	<input type="checkbox"/>
Brass	Not Available
Black	<input type="checkbox"/>
White	<input type="checkbox"/>
Chrome	<input type="checkbox"/>
Silver	<input type="checkbox"/>
<i>All other accessories supplied loose if required</i>	

Special Instructions if required:

**HALLMARK
PANELS LIMITED**

Valletta House, Valletta Street, Hedon Road, Hull. HU9 5NP
Customer Service: +44 (0)1482 703222, Fax: +44 (0)1482 701185, Reception: +44 (0)1482 781111

All dimensions are approximate and within manufacturing tolerances of +/-3mm. However, due to our policy of continuous development, we reserve the right to change specifications without notice

CUSTOMER SPECIFICATION

ORDER FORM

ROUTE	
Invoice Address:	Delivery Address:
Order No:	Date Required: / /
Date: / /	Ref:
	Contact:

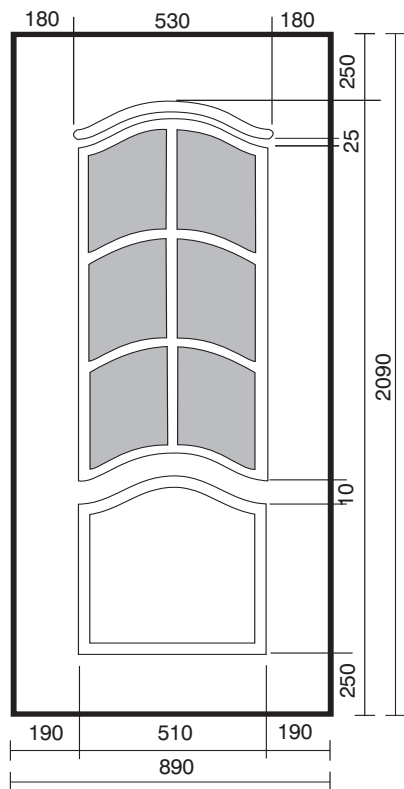

SHADED AREA INDICATES GLAZING AREAS

FAX SALES LINE
01482 701185

PHOTOCOPY THIS SHEET BEFORE COMPLETING & FAXING WITH YOUR OFFICIAL ORDER

Door: MANZANARES
Panel Type: Solid <input type="checkbox"/> One <input type="checkbox"/>
Door Panel Colour/Profile _____
Door Panel Thickness: <input type="text"/> mm Door Panel Quantity: <input type="text"/>
Reinforcing (Tick if required) 4mm Mdf <input type="checkbox"/> Aluminium <input type="checkbox"/> 9mm Mdf <input type="checkbox"/> Solid Mdf <input type="checkbox"/>
Cut to size (if required) Width _____ mm x (Height _____ mm) Min Cut : Width 560mm Height:1640mm
Glass Design Required: _____
Backing Glass Pattern: _____
Spacer Bar Colour: _____ Silver Spacer Bar as standard subject to design
Accessories
Accessories not supplied fitted on this design - can be supplied loose if requested.

Special Instructions if required:

CUSTOMER SPECIFICATION

ORDER FORM

<i>ROUTE</i>		
<i>Invoice Address:</i>	<i>Delivery Address:</i>	
	<i>Date Required:</i> / /	
<i>Order No:</i>	<i>Ref:</i>	
<i>Date:</i> / /	<i>Contact:</i>	

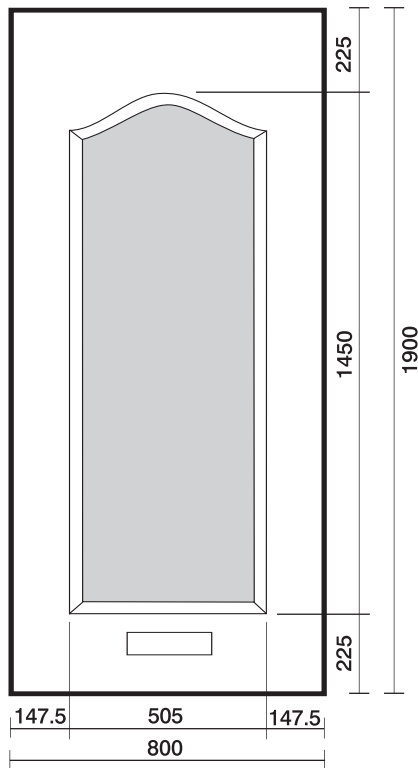

<i>Door:</i> MARSDEN CLASSIC	
<i>Panel Type:</i> Solid <input type="checkbox"/> One <input type="checkbox"/>	
<i>Door Panel Colour/Profile:</i> _____	
<i>Door Panel Thickness:</i> <input type="text"/> mm	<i>Door Panel Quantity:</i> <input type="text"/>
<i>Reinforcing:</i> 9mm MDF as standard	
<i>Cut to size (if required)</i> Width _____ mm) x (Height _____ mm) Min Cut : Width 555mm Height:1500mm	
<i>Glass Design Required:</i> _____	
<i>Backing Glass Pattern:</i> _____	
<i>Spacer Bar Colour:</i> _____ <i>Silver Spacer Bar as standard subject to design</i>	
Accessories (Tick extras required)	
<i>N.B. Letter PLate fitted in baserail as standard.</i>	
<i>Gold</i>	<i>Letter Plate</i> <input type="checkbox"/>
<i>Brass</i>	<i>Not Available</i>
<i>Black</i>	<input type="checkbox"/>
<i>White</i>	<input type="checkbox"/>
<i>Chrome</i>	<input type="checkbox"/>
<i>Silver</i>	<input type="checkbox"/>
<i>(Certain accessories not applicable with glazed options)</i>	

FAX SALES LINE

01482 701185

PHOTOCOPY THIS SHEET BEFORE COMPLETING & FAXING WITH YOUR OFFICIAL ORDER

Special Instructions if required:

**HALLMARK
PANELS LIMITED**

Valletta House, Valletta Street, Hedon Road, Hull. HU9 5NP
Customer Service: +44 (0)1482 703222, Fax: +44 (0)1482 701185, Reception: +44 (0)1482 781111

All dimensions are approximate and within manufacturing tolerances of +/-3mm. However, due to our policy of continuous development, we reserve the right to change specifications without notice

CUSTOMER SPECIFICATION

ORDER FORM

ROUTE	
Invoice Address:	Delivery Address:
	Date Required: / /
Order No:	Ref:
Date: / /	Contact:

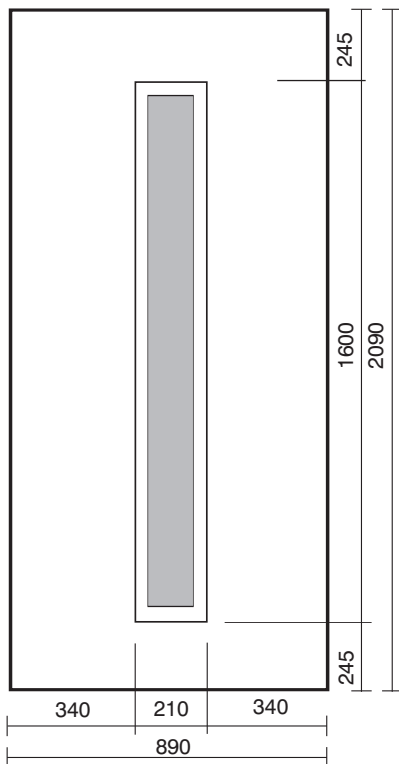

SHADED AREA INDICATES GLAZING AREAS

FAX SALES LINE

01482 701185

PHOTOCOPY THIS SHEET BEFORE COMPLETING & FAXING WITH YOUR OFFICIAL ORDER

Door: MONTI
Panel Type: Solid <input type="checkbox"/> One <input type="checkbox"/>
Door Panel Colour/Profile _____
Door Panel Thickness: <input type="text"/> mm Door Panel Quantity: <input type="text"/>
Reinforcing (Tick if required) 4mm Mdf <input type="checkbox"/> Aluminium <input type="checkbox"/> 9mm Mdf <input type="checkbox"/> Solid Mdf <input type="checkbox"/>
Cut to size (if required) Width _____ mm x (Height _____ mm) Min Cut : Width 260mm Height:1650mm
Glass Design Required: _____
Backing Glass Pattern: _____
Spacer Bar Colour: _____ Silver Spacer Bar as standard subject to design
Accessories Accessories not supplied fitted on this design - can be supplied loose if requested.

Special Instructions if required:

CUSTOMER SPECIFICATION

ORDER FORM

ROUTE		
<i>Invoice Address:</i>	<i>Delivery Address:</i>	
<i>Order No.:</i>	<i>Date Required:</i> / /	
<i>Date:</i> / /	<i>Ref:</i>	
		<i>Contact:</i>

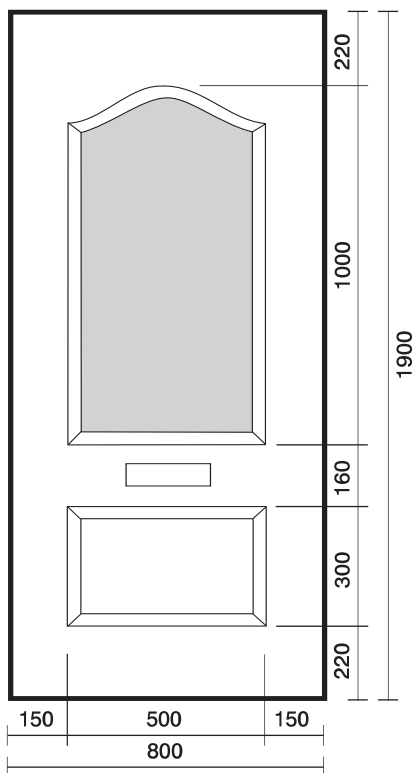

SHADED AREA INDICATES GLAZING AREAS

<i>Door:</i> NEWBY							
<i>Panel Type:</i> Solid <input type="checkbox"/> One <input type="checkbox"/>							
<i>Door Panel Colour/Profile</i> _____							
<i>Door Panel Thickness:</i> <input type="text"/> mm				<i>Door Panel Quantity:</i> <input type="text"/>			
<i>Reinforcing (Tick if required)</i>							
4mm Mdf <input type="checkbox"/>		Aluminium <input type="checkbox"/>		9mm Mdf <input type="checkbox"/>		Solid Mdf <input type="checkbox"/>	
<i>Cut to size (if required)</i>							
<i>Width</i> _____ <i>mm</i>) x (<i>Height</i> _____ <i>mm</i>)							
<i>Min Cut : Width 550mm Height:1510mm</i>							
<i>Glass Design Required:</i> _____							
<i>Backing Glass Pattern:</i> _____							
<i>Spacer Bar Colour:</i> _____							
<i>Silver Spacer Bar as standard subject to design</i>							
Accessories (Tick extras required)							
<i>N.B. Letter PLate fitted in midrail as standard. Moved to bottom if knocker supplied</i>							
	<i>Urn Knocker</i>	<i>Urn with Spy</i>	<i>Lions Head</i>	<i>Spy Hole</i>	<i>Slim Urn</i>	<i>Slim Urn with Spy</i>	<i>Letter Plate</i>
<i>Gold</i>	<input type="checkbox"/>	<input type="checkbox"/>	<input type="checkbox"/> <i>Not Available</i>	<input type="checkbox"/> <i>Not Available</i>	<input type="checkbox"/>	<input type="checkbox"/>	<input type="checkbox"/>
<i>Brass</i>	<input type="checkbox"/>	<input type="checkbox"/>	<input type="checkbox"/>	<input type="checkbox"/>	<input type="checkbox"/> <i>Not Available</i>	<input type="checkbox"/> <i>Not Available</i>	<input type="checkbox"/> <i>Not Available</i>
<i>Black</i>	<input type="checkbox"/>	<input type="checkbox"/>	<input type="checkbox"/>	<input type="checkbox"/> <i>Not Available</i>	<input type="checkbox"/>	<input type="checkbox"/>	<input type="checkbox"/>
<i>White</i>	<input type="checkbox"/>	<input type="checkbox"/>	<input type="checkbox"/>	<input type="checkbox"/> <i>Not Available</i>	<input type="checkbox"/>	<input type="checkbox"/>	<input type="checkbox"/>
<i>Chrome</i>	<input type="checkbox"/>	<input type="checkbox"/>	<input type="checkbox"/> <i>Not Available</i>	<input type="checkbox"/>	<input type="checkbox"/> <i>Not Available</i>	<input type="checkbox"/> <i>Not Available</i>	<input type="checkbox"/>
<i>Silver</i>	<input type="checkbox"/>	<input type="checkbox"/>	<input type="checkbox"/> <i>Not Available</i>	<input type="checkbox"/> <i>Not Available</i>	<input type="checkbox"/> <i>Not Available</i>	<input type="checkbox"/> <i>Not Available</i>	<input type="checkbox"/>
<i>(Certain accessories not applicable with glazed options)</i>							

FAX SALES LINE

**01482
701185**

**PHOTOCOPY THIS SHEET
BEFORE COMPLETING &
FAXING WITH YOUR
OFFICIAL ORDER**

Special Instructions if required:

**HALLMARK
PANELS LIMITED**

Valletta House, Valletta Street, Hedon Road, Hull. HU9 5NP
Customer Service: +44 (0)1482 703222, Fax: +44 (0)1482 701185, Reception: +44 (0)1482 781111

All dimensions are approximate and within manufacturing tolerances of +/-3mm. However, due to our policy of continuous development, we reserve the right to change specifications without notice

CUSTOMER SPECIFICATION

ORDER FORM

ROUTE		
Invoice Address:	Delivery Address:	
	Date Required: / /	
Order No:	Ref:	
Date: / /	Contact:	

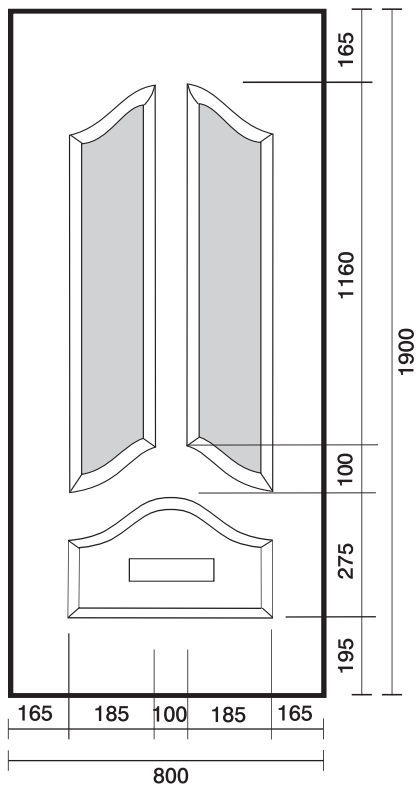

SHADED AREA INDICATES GLAZING AREAS

FAX SALES LINE

**01482
701185**

**PHOTOCOPY THIS SHEET
BEFORE COMPLETING &
FAXING WITH YOUR
OFFICIAL ORDER**

Door: NORMANBY							
Panel Type: Solid <input type="checkbox"/> Two <input type="checkbox"/>							
Door Panel Colour/Profile _____							
Door Panel Thickness: <input type="text"/> mm		Door Panel Quantity: <input type="text"/>					
Reinforcing (Tick if required)							
4mm Mdf <input type="checkbox"/>		Aluminium <input type="checkbox"/>		9mm Mdf <input type="checkbox"/>		Solid Mdf <input type="checkbox"/>	
Cut to size (if required)							
Width _____ mm) x (Height _____ mm)							
Min Cut : Width 520mm Height:1585mm							
Glass Design Required: _____							
Backing Glass Pattern: _____							
Spacer Bar Colour: _____							
Silver Spacer Bar as standard subject to design							
Accessories (Tick extras required)							
<i>N.B. Letter PLate fitted in bottom moulding as standard.</i>							
	Urn Knocker	Urn with Spy	Lions Head	Spy Hole	Slim Urn	Slim Urn with Spy	Letter Plate
Gold	<input type="checkbox"/>	<input type="checkbox"/>	Not Available	Not Available	<input type="checkbox"/>	<input type="checkbox"/>	<input type="checkbox"/>
Brass	<input type="checkbox"/>	<input type="checkbox"/>	<input type="checkbox"/>	<input type="checkbox"/>	Not Available	Not Available	Not Available
Black	<input type="checkbox"/>	<input type="checkbox"/>	<input type="checkbox"/>	Not Available	<input type="checkbox"/>	<input type="checkbox"/>	<input type="checkbox"/>
White	<input type="checkbox"/>	<input type="checkbox"/>	<input type="checkbox"/>	Not Available	<input type="checkbox"/>	<input type="checkbox"/>	<input type="checkbox"/>
Chrome	<input type="checkbox"/>	<input type="checkbox"/>	Not Available	<input type="checkbox"/>	Not Available	Not Available	<input type="checkbox"/>
Silver	<input type="checkbox"/>	<input type="checkbox"/>	Not Available	Not Available	Not Available	Not Available	<input type="checkbox"/>
<i>(Certain accessories not applicable with glazed options)</i>							

Special Instructions if required:

CUSTOMER SPECIFICATION

ORDER FORM

ROUTE		
Invoice Address:	Delivery Address:	
	Date Required: / /	
Order No:	Ref:	
Date: / /	Contact:	

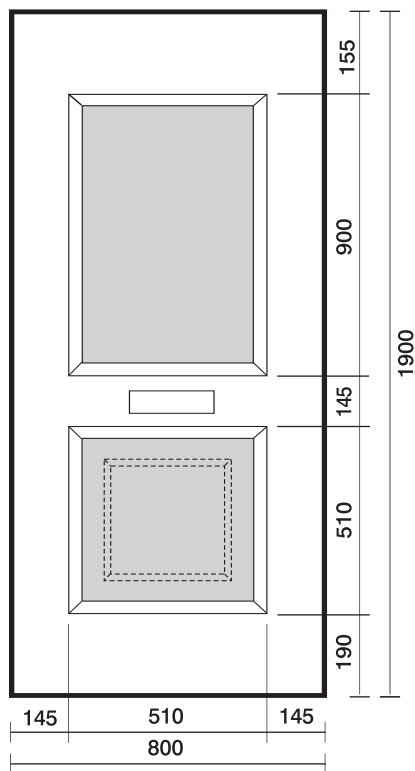

SHADED AREA INDICATES GLAZING AREAS

FAX SALES LINE

01482

701185

**PHOTOCOPY THIS SHEET
BEFORE COMPLETING &
FAXING WITH YOUR
OFFICIAL ORDER**

Door: OAKWELL CLASSIC							
Panel Type: Solid <input type="checkbox"/> One <input type="checkbox"/> Two <input type="checkbox"/>							
Door Panel Colour/Profile _____							
Door Panel Thickness: <input type="text"/> mm		Door Panel Quantity: <input type="text"/>					
Reinforcing (Tick if required)							
4mm Mdf <input type="checkbox"/>		Aluminium <input type="checkbox"/>		9mm Mdf <input type="checkbox"/>		Solid Mdf <input type="checkbox"/>	
Cut to size (if required)							
Width _____ mm) x (Height _____ mm)							
Min Cut : Width 560mm Height:1605mm							
Glass Design Required: _____							
Backing Glass Pattern: _____							
Spacer Bar Colour: _____							
Silver Spacer Bar as standard subject to design							
Accessories (Tick extras required)							
<i>N.B. Letter PLate fitted in midrail as standard. Moved to bottom if knocker supplied</i>							
	Urn Knocker	Urn with Spy	Lions Head	Spy Hole	Slim Um	Slim Urn with Spy	Letter Plate
Gold	<input type="checkbox"/>	<input type="checkbox"/>	Not Available	Not Available	<input type="checkbox"/>	<input type="checkbox"/>	<input type="checkbox"/>
Brass	<input type="checkbox"/>	<input type="checkbox"/>	<input type="checkbox"/>	<input type="checkbox"/>	Not Available	Not Available	Not Available
Black	<input type="checkbox"/>	<input type="checkbox"/>	<input type="checkbox"/>	Not Available	<input type="checkbox"/>	<input type="checkbox"/>	<input type="checkbox"/>
White	<input type="checkbox"/>	<input type="checkbox"/>	<input type="checkbox"/>	Not Available	<input type="checkbox"/>	<input type="checkbox"/>	<input type="checkbox"/>
Chrome	<input type="checkbox"/>	<input type="checkbox"/>	Not Available	<input type="checkbox"/>	Not Available	Not Available	<input type="checkbox"/>
Silver	<input type="checkbox"/>	<input type="checkbox"/>	Not Available	Not Available	Not Available	Not Available	<input type="checkbox"/>
(Certain accessories not applicable with glazed options)							

Special Instructions if required:

**HALLMARK
PANELS LIMITED**

Valletta House, Valletta Street, Hedon Road, Hull. HU9 5NP
Customer Service: +44 (0)1482 703222, Fax: +44 (0)1482 701185, Reception: +44 (0)1482 781111

All dimensions are approximate and within manufacturing tolerances of +/-3mm. However, due to our policy of continuous development, we reserve the right to change specifications without notice

CUSTOMER SPECIFICATION

ORDER FORM

ROUTE		
Invoice Address:	Delivery Address:	
	Date Required: / /	
Order No:	Ref:	
Date: / /	Contact:	

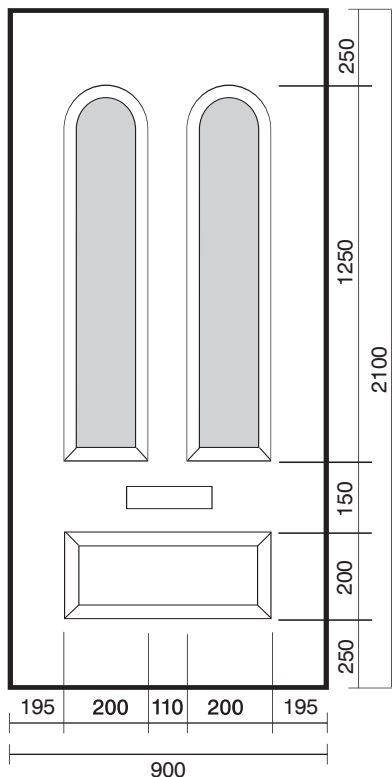

SHADED AREA INDICATES GLAZING AREAS

FAX SALES LINE

01482 701185

PHOTOCOPY THIS SHEET BEFORE COMPLETING & FAXING WITH YOUR OFFICIAL ORDER

Door: RAGLEY							
Panel Type: Solid <input type="checkbox"/> Two <input type="checkbox"/>							
Door Panel Colour/Profile _____							
Door Panel Thickness: <input type="text"/> mm				Door Panel Quantity: <input type="text"/>			
Reinforcing (Tick if required)							
4mm Mdf <input type="checkbox"/>		Aluminium <input type="checkbox"/>		9mm Mdf <input type="checkbox"/>		Solid Mdf <input type="checkbox"/>	
Cut to size (if required)							
Width _____ mm x (Height _____ mm)							
Min Cut : Width 560mm Height:1605mm							
Glass Design Required: _____							
Backing Glass Pattern: _____							
Spacer Bar Colour: _____							
Silver Spacer Bar as standard subject to design							
Accessories (Tick extras required)							
N.B. Letter PLate fitted in midrail as standard.							
	Urn Knocker	Urn with Spy	Lions Head	Spy Hole	Slim Um	Slim Urn with Spy	Letter Plate
Gold	<input type="checkbox"/>	<input type="checkbox"/>	Not Available	Not Available	<input type="checkbox"/>	<input type="checkbox"/>	<input type="checkbox"/>
Brass	<input type="checkbox"/>	<input type="checkbox"/>	<input type="checkbox"/>	<input type="checkbox"/>	Not Available	Not Available	Not Available
Black	<input type="checkbox"/>	<input type="checkbox"/>	<input type="checkbox"/>	Not Available	<input type="checkbox"/>	<input type="checkbox"/>	<input type="checkbox"/>
White	<input type="checkbox"/>	<input type="checkbox"/>	<input type="checkbox"/>	Not Available	<input type="checkbox"/>	<input type="checkbox"/>	<input type="checkbox"/>
Chrome	<input type="checkbox"/>	<input type="checkbox"/>	Not Available	<input type="checkbox"/>	Not Available	Not Available	<input type="checkbox"/>
Silver	<input type="checkbox"/>	<input type="checkbox"/>	Not Available	Not Available	Not Available	Not Available	<input type="checkbox"/>
(Certain accessories not applicable with glazed options)							

Special Instructions if required:

CUSTOMER SPECIFICATION

ORDER FORM

ROUTE	
Invoice Address:	Delivery Address:
Date Required: / /	
Order No:	Ref:
Date: / /	Contact:

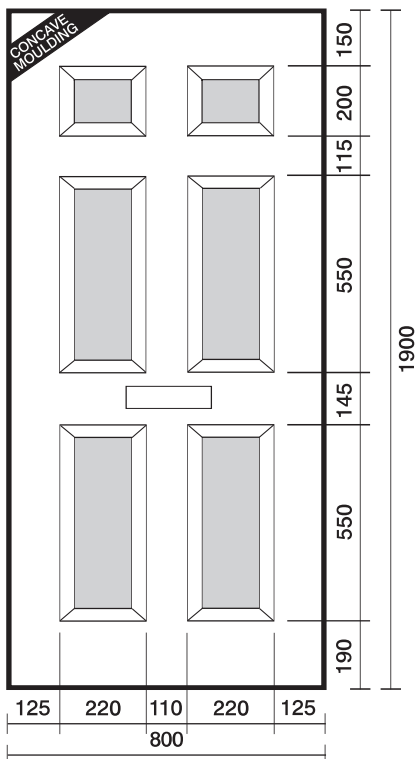

SHADED AREA INDICATES GLAZING AREAS

FAX SALES LINE

**01482
701185**

**PHOTOCOPY THIS SHEET
BEFORE COMPLETING &
FAXING WITH YOUR
OFFICIAL ORDER**

Door: STANFORD																																																		
Panel Type: Solid <input type="checkbox"/> Two <input type="checkbox"/> Four <input type="checkbox"/> Six <input type="checkbox"/>																																																		
Door Panel Colour/Profile _____																																																		
Door Panel Thickness: <input style="width: 50px;" type="text"/> mm	Door Panel Quantity: <input style="width: 50px;" type="text"/>																																																	
Reinforcing with 4mm Mdf as standard																																																		
Cut to size (if required) Width _____ mm x (Height _____ mm) Min Cut : Width 600mm Height:1610mm																																																		
Glass Design Required: _____																																																		
Backing Glass Pattern: _____																																																		
Spacer Bar Colour: _____ <i>Silver Spacer Bar as standard subject to design</i>																																																		
Accessories (Tick extras required)																																																		
<i>N.B. Letter PLate fitted in midrail as standard.</i>																																																		
	<table border="1" style="width: 100%; border-collapse: collapse; font-size: 10px;"> <thead> <tr> <th style="padding: 2px;">Urn Knocker</th> <th style="padding: 2px;">Urn with Spy</th> <th style="padding: 2px;">Lions Head</th> <th style="padding: 2px;">Spy Hole</th> <th style="padding: 2px;">Slim Urn</th> <th style="padding: 2px;">Slim Urn with Spy</th> <th style="padding: 2px;">Letter Plate</th> </tr> </thead> <tbody> <tr> <td style="padding: 2px;">Gold</td> <td style="padding: 2px; text-align: center;"><input type="checkbox"/></td> <td style="padding: 2px; text-align: center;"><input type="checkbox"/></td> <td style="padding: 2px; text-align: center;">Not Available</td> <td style="padding: 2px; text-align: center;"><input type="checkbox"/></td> <td style="padding: 2px; text-align: center;"><input type="checkbox"/></td> <td style="padding: 2px; text-align: center;"><input type="checkbox"/></td> </tr> <tr> <td style="padding: 2px;">Brass</td> <td style="padding: 2px; text-align: center;"><input type="checkbox"/></td> <td style="padding: 2px; text-align: center;"><input type="checkbox"/></td> <td style="padding: 2px; text-align: center;"><input type="checkbox"/></td> <td style="padding: 2px; text-align: center;">Not Available</td> <td style="padding: 2px; text-align: center;">Not Available</td> <td style="padding: 2px; text-align: center;">Not Available</td> </tr> <tr> <td style="padding: 2px;">Black</td> <td style="padding: 2px; text-align: center;"><input type="checkbox"/></td> <td style="padding: 2px; text-align: center;"><input type="checkbox"/></td> <td style="padding: 2px; text-align: center;"><input type="checkbox"/></td> <td style="padding: 2px; text-align: center;">Not Available</td> <td style="padding: 2px; text-align: center;"><input type="checkbox"/></td> <td style="padding: 2px; text-align: center;"><input type="checkbox"/></td> </tr> <tr> <td style="padding: 2px;">White</td> <td style="padding: 2px; text-align: center;"><input type="checkbox"/></td> <td style="padding: 2px; text-align: center;"><input type="checkbox"/></td> <td style="padding: 2px; text-align: center;"><input type="checkbox"/></td> <td style="padding: 2px; text-align: center;">Not Available</td> <td style="padding: 2px; text-align: center;"><input type="checkbox"/></td> <td style="padding: 2px; text-align: center;"><input type="checkbox"/></td> </tr> <tr> <td style="padding: 2px;">Chrome</td> <td style="padding: 2px; text-align: center;"><input type="checkbox"/></td> <td style="padding: 2px; text-align: center;"><input type="checkbox"/></td> <td style="padding: 2px; text-align: center;">Not Available</td> <td style="padding: 2px; text-align: center;"><input type="checkbox"/></td> <td style="padding: 2px; text-align: center;">Not Available</td> <td style="padding: 2px; text-align: center;"><input type="checkbox"/></td> </tr> <tr> <td style="padding: 2px;">Silver</td> <td style="padding: 2px; text-align: center;"><input type="checkbox"/></td> <td style="padding: 2px; text-align: center;"><input type="checkbox"/></td> <td style="padding: 2px; text-align: center;">Not Available</td> <td style="padding: 2px; text-align: center;">Not Available</td> <td style="padding: 2px; text-align: center;">Not Available</td> <td style="padding: 2px; text-align: center;"><input type="checkbox"/></td> </tr> </tbody> </table>	Urn Knocker	Urn with Spy	Lions Head	Spy Hole	Slim Urn	Slim Urn with Spy	Letter Plate	Gold	<input type="checkbox"/>	<input type="checkbox"/>	Not Available	<input type="checkbox"/>	<input type="checkbox"/>	<input type="checkbox"/>	Brass	<input type="checkbox"/>	<input type="checkbox"/>	<input type="checkbox"/>	Not Available	Not Available	Not Available	Black	<input type="checkbox"/>	<input type="checkbox"/>	<input type="checkbox"/>	Not Available	<input type="checkbox"/>	<input type="checkbox"/>	White	<input type="checkbox"/>	<input type="checkbox"/>	<input type="checkbox"/>	Not Available	<input type="checkbox"/>	<input type="checkbox"/>	Chrome	<input type="checkbox"/>	<input type="checkbox"/>	Not Available	<input type="checkbox"/>	Not Available	<input type="checkbox"/>	Silver	<input type="checkbox"/>	<input type="checkbox"/>	Not Available	Not Available	Not Available	<input type="checkbox"/>
Urn Knocker	Urn with Spy	Lions Head	Spy Hole	Slim Urn	Slim Urn with Spy	Letter Plate																																												
Gold	<input type="checkbox"/>	<input type="checkbox"/>	Not Available	<input type="checkbox"/>	<input type="checkbox"/>	<input type="checkbox"/>																																												
Brass	<input type="checkbox"/>	<input type="checkbox"/>	<input type="checkbox"/>	Not Available	Not Available	Not Available																																												
Black	<input type="checkbox"/>	<input type="checkbox"/>	<input type="checkbox"/>	Not Available	<input type="checkbox"/>	<input type="checkbox"/>																																												
White	<input type="checkbox"/>	<input type="checkbox"/>	<input type="checkbox"/>	Not Available	<input type="checkbox"/>	<input type="checkbox"/>																																												
Chrome	<input type="checkbox"/>	<input type="checkbox"/>	Not Available	<input type="checkbox"/>	Not Available	<input type="checkbox"/>																																												
Silver	<input type="checkbox"/>	<input type="checkbox"/>	Not Available	Not Available	Not Available	<input type="checkbox"/>																																												
<i>(Certain accessories not applicable with glazed options)</i>																																																		

Special Instructions if required:

**HALLMARK
PANELS LIMITED**

Valletta House, Valletta Street, Hedon Road, Hull. HU9 5NP
Customer Service: +44 (0)1482 703222, Fax: +44 (0)1482 701185, Reception: +44 (0)1482 781111

All dimensions are approximate and within manufacturing tolerances of +/-3mm. However, due to our policy of continuous development, we reserve the right to change specifications without notice

CUSTOMER SPECIFICATION

ORDER FORM

ROUTE		
Invoice Address:	Delivery Address:	
	Date Required: / /	
Order No:	Ref:	
Date: / /	Contact:	

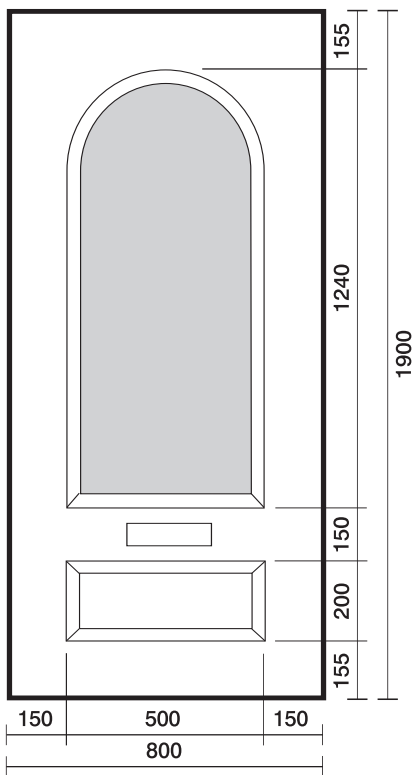

SHADED AREA INDICATES GLAZING AREAS

FAX SALES LINE

01482 701185

PHOTOCOPY THIS SHEET BEFORE COMPLETING & FAXING WITH YOUR OFFICIAL ORDER

Door: THORESBY							
Panel Type: Solid <input type="checkbox"/> One <input type="checkbox"/>							
Door Panel Colour/Profile _____							
Door Panel Thickness: <input type="text"/> mm				Door Panel Quantity: <input type="text"/>			
Reinforcing (Tick if required)							
4mm Mdf <input type="checkbox"/>		Aluminium <input type="checkbox"/>		9mm Mdf <input type="checkbox"/>		Solid Mdf <input type="checkbox"/>	
Cut to size (if required)							
Width _____ mm x (Height _____ mm)							
Min Cut : Width 550mm Height:1640mm							
Glass Design Required: _____							
Backing Glass Pattern: _____							
Spacer Bar Colour: _____							
Silver Spacer Bar as standard subject to design							
Accessories (Tick extras required)							
<i>N.B. Letter PLate fitted in midrail as standard.</i>							
	Urn Knocker	Urn with Spy	Lions Head	Spy Hole	Slim Um	Slim Urn with Spy	Letter Plate
Gold	<input type="checkbox"/>	<input type="checkbox"/>	Not Available	Not Available	<input type="checkbox"/>	<input type="checkbox"/>	<input type="checkbox"/>
Brass	<input type="checkbox"/>	<input type="checkbox"/>	<input type="checkbox"/>	<input type="checkbox"/>	Not Available	Not Available	Not Available
Black	<input type="checkbox"/>	<input type="checkbox"/>	<input type="checkbox"/>	Not Available	<input type="checkbox"/>	<input type="checkbox"/>	<input type="checkbox"/>
White	<input type="checkbox"/>	<input type="checkbox"/>	<input type="checkbox"/>	Not Available	<input type="checkbox"/>	<input type="checkbox"/>	<input type="checkbox"/>
Chrome	<input type="checkbox"/>	<input type="checkbox"/>	Not Available	<input type="checkbox"/>	Not Available	Not Available	<input type="checkbox"/>
Silver	<input type="checkbox"/>	<input type="checkbox"/>	Not Available	Not Available	Not Available	Not Available	<input type="checkbox"/>
<i>(Certain accessories not applicable with glazed options)</i>							

Special Instructions if required:

CUSTOMER SPECIFICATION

ORDER FORM

ROUTE	
Invoice Address:	Delivery Address:
	Date Required: / /
Order No:	Ref:
Date: / /	Contact:

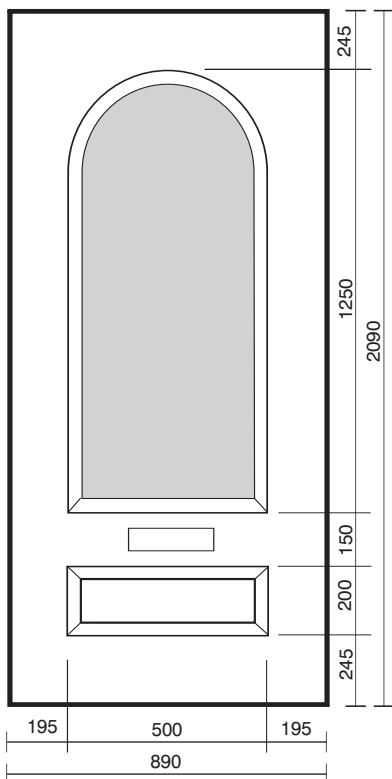

SHADED AREA INDICATES GLAZING AREAS

FAX SALES LINE

01482 701185

PHOTOCOPY THIS SHEET BEFORE COMPLETING & FAXING WITH YOUR OFFICIAL ORDER

Door: WHITLEY																																																								
Panel Type: Solid <input type="checkbox"/> One <input type="checkbox"/>																																																								
Door Panel Colour/Profile _____																																																								
Door Panel Thickness: <input type="text"/> mm Door Panel Quantity: <input type="text"/>																																																								
Reinforcing with 9mm Mdf as standard																																																								
Cut to size (if required) Width _____ mm x (Height _____ mm) Min Cut : Width 550mm Height:1650mm																																																								
Glass Design Required: _____																																																								
Backing Glass Pattern: _____																																																								
Spacer Bar Colour: _____ Silver Spacer Bar as standard subject to design																																																								
Accessories (Tick extras required)																																																								
<i>N.B. Letter PLate fitted in midrail as standard.</i>																																																								
<table border="1"> <thead> <tr> <th></th> <th>Urn Knocker</th> <th>Urn with Spy</th> <th>Lions Head</th> <th>Spy Hole</th> <th>Slim Um</th> <th>Slim Urn with Spy</th> <th>Letter Plate</th> </tr> </thead> <tbody> <tr> <td>Gold</td> <td><input type="checkbox"/></td> <td><input type="checkbox"/></td> <td>Not Available</td> <td>Not Available</td> <td><input type="checkbox"/></td> <td><input type="checkbox"/></td> <td><input type="checkbox"/></td> </tr> <tr> <td>Brass</td> <td><input type="checkbox"/></td> <td><input type="checkbox"/></td> <td><input type="checkbox"/></td> <td><input type="checkbox"/></td> <td>Not Available</td> <td>Not Available</td> <td>Not Available</td> </tr> <tr> <td>Black</td> <td><input type="checkbox"/></td> <td><input type="checkbox"/></td> <td><input type="checkbox"/></td> <td>Not Available</td> <td><input type="checkbox"/></td> <td><input type="checkbox"/></td> <td><input type="checkbox"/></td> </tr> <tr> <td>White</td> <td><input type="checkbox"/></td> <td><input type="checkbox"/></td> <td><input type="checkbox"/></td> <td>Not Available</td> <td><input type="checkbox"/></td> <td><input type="checkbox"/></td> <td><input type="checkbox"/></td> </tr> <tr> <td>Chrome</td> <td><input type="checkbox"/></td> <td><input type="checkbox"/></td> <td>Not Available</td> <td><input type="checkbox"/></td> <td>Not Available</td> <td>Not Available</td> <td><input type="checkbox"/></td> </tr> <tr> <td>Silver</td> <td><input type="checkbox"/></td> <td><input type="checkbox"/></td> <td>Not Available</td> <td>Not Available</td> <td>Not Available</td> <td>Not Available</td> <td><input type="checkbox"/></td> </tr> </tbody> </table>		Urn Knocker	Urn with Spy	Lions Head	Spy Hole	Slim Um	Slim Urn with Spy	Letter Plate	Gold	<input type="checkbox"/>	<input type="checkbox"/>	Not Available	Not Available	<input type="checkbox"/>	<input type="checkbox"/>	<input type="checkbox"/>	Brass	<input type="checkbox"/>	<input type="checkbox"/>	<input type="checkbox"/>	<input type="checkbox"/>	Not Available	Not Available	Not Available	Black	<input type="checkbox"/>	<input type="checkbox"/>	<input type="checkbox"/>	Not Available	<input type="checkbox"/>	<input type="checkbox"/>	<input type="checkbox"/>	White	<input type="checkbox"/>	<input type="checkbox"/>	<input type="checkbox"/>	Not Available	<input type="checkbox"/>	<input type="checkbox"/>	<input type="checkbox"/>	Chrome	<input type="checkbox"/>	<input type="checkbox"/>	Not Available	<input type="checkbox"/>	Not Available	Not Available	<input type="checkbox"/>	Silver	<input type="checkbox"/>	<input type="checkbox"/>	Not Available	Not Available	Not Available	Not Available	<input type="checkbox"/>
	Urn Knocker	Urn with Spy	Lions Head	Spy Hole	Slim Um	Slim Urn with Spy	Letter Plate																																																	
Gold	<input type="checkbox"/>	<input type="checkbox"/>	Not Available	Not Available	<input type="checkbox"/>	<input type="checkbox"/>	<input type="checkbox"/>																																																	
Brass	<input type="checkbox"/>	<input type="checkbox"/>	<input type="checkbox"/>	<input type="checkbox"/>	Not Available	Not Available	Not Available																																																	
Black	<input type="checkbox"/>	<input type="checkbox"/>	<input type="checkbox"/>	Not Available	<input type="checkbox"/>	<input type="checkbox"/>	<input type="checkbox"/>																																																	
White	<input type="checkbox"/>	<input type="checkbox"/>	<input type="checkbox"/>	Not Available	<input type="checkbox"/>	<input type="checkbox"/>	<input type="checkbox"/>																																																	
Chrome	<input type="checkbox"/>	<input type="checkbox"/>	Not Available	<input type="checkbox"/>	Not Available	Not Available	<input type="checkbox"/>																																																	
Silver	<input type="checkbox"/>	<input type="checkbox"/>	Not Available	Not Available	Not Available	Not Available	<input type="checkbox"/>																																																	
(Certain accessories not applicable with glazed options)																																																								

Special Instructions if required:

HALLMARK
PANELS LIMITED

Valletta House, Valletta Street, Hedon Road, Hull. HU9 5NP
Customer Service: +44 (0)1482 703222, Fax: +44 (0)1482 701185, Reception: +44 (0)1482 781111

All dimensions are approximate and within manufacturing tolerances of +/-3mm. However, due to our policy of continuous development, we reserve the right to change specifications without notice

CUSTOMER SPECIFICATION

ORDER FORM

ROUTE		
<i>Invoice Address:</i>	<i>Delivery Address:</i>	
<i>Order No.:</i>	<i>Date Required:</i> / /	
<i>Date:</i> / /	<i>Ref:</i>	
		<i>Contact:</i>

All panels will be manufactured to our standard size Winslow unless otherwise stated.

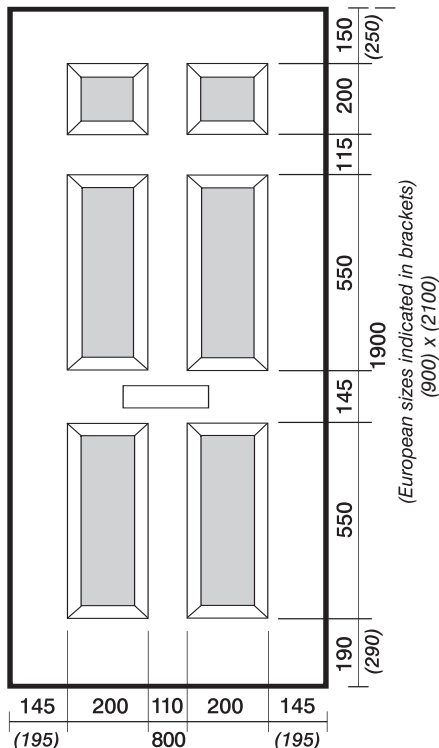

SHADED AREA INDICATES GLAZING AREAS

FAX SALES LINE

**01482
701185**

**PHOTOCOPY THIS SHEET
BEFORE COMPLETING &
FAXING WITH YOUR
OFFICIAL ORDER**

<i>Door:</i> WINSLOW <input type="checkbox"/> WINSLOW EURO <input type="checkbox"/>																																																		
<i>Panel Type:</i> Solid <input type="checkbox"/> Two <input type="checkbox"/> Four <input type="checkbox"/> Six <input type="checkbox"/>																																																		
<i>Door Panel Colour/Profile</i> _____																																																		
<i>Door Panel Thickness:</i> <input type="text"/> mm	<i>Door Panel Quantity:</i> <input type="text"/>																																																	
<i>Reinforcing (Tick if required)</i>																																																		
4mm Mdf <input type="checkbox"/> Aluminium <input type="checkbox"/> 9mm Mdf <input type="checkbox"/> Solid Mdf <input type="checkbox"/>																																																		
<i>Cut to size (if required)</i>																																																		
Width _____ mm) x (Height _____ mm)																																																		
Min Cut : Width 560mm Height:1610mm																																																		
<i>Glass Design Required:</i> _____																																																		
<i>Backing Glass Pattern:</i> _____																																																		
<i>Spacer Bar Colour:</i> _____																																																		
Silver Spacer Bar as standard subject to design																																																		
Accessories (Tick extras required)																																																		
<i>N.B. Letter PLate fitted in midrail as standard.</i>																																																		
	<table border="1" style="width: 100%; border-collapse: collapse; font-size: 10px;"> <thead> <tr> <th style="padding: 2px;">Urn Knocker</th> <th style="padding: 2px;">Urn with Spy</th> <th style="padding: 2px;">Lions Head</th> <th style="padding: 2px;">Spy Hole</th> <th style="padding: 2px;">Slim Um</th> <th style="padding: 2px;">Slim Urn with Spy</th> <th style="padding: 2px;">Letter Plate</th> </tr> </thead> <tbody> <tr> <td style="padding: 2px;">Gold</td> <td style="padding: 2px; text-align: center;"><input type="checkbox"/></td> <td style="padding: 2px; text-align: center;"><input type="checkbox"/></td> <td style="padding: 2px; text-align: center;">Not Available</td> <td style="padding: 2px; text-align: center;"><input type="checkbox"/></td> <td style="padding: 2px; text-align: center;"><input type="checkbox"/></td> <td style="padding: 2px; text-align: center;"><input type="checkbox"/></td> </tr> <tr> <td style="padding: 2px;">Brass</td> <td style="padding: 2px; text-align: center;"><input type="checkbox"/></td> <td style="padding: 2px; text-align: center;"><input type="checkbox"/></td> <td style="padding: 2px; text-align: center;"><input type="checkbox"/></td> <td style="padding: 2px; text-align: center;">Not Available</td> <td style="padding: 2px; text-align: center;">Not Available</td> <td style="padding: 2px; text-align: center;">Not Available</td> </tr> <tr> <td style="padding: 2px;">Black</td> <td style="padding: 2px; text-align: center;"><input type="checkbox"/></td> <td style="padding: 2px; text-align: center;"><input type="checkbox"/></td> <td style="padding: 2px; text-align: center;"><input type="checkbox"/></td> <td style="padding: 2px; text-align: center;">Not Available</td> <td style="padding: 2px; text-align: center;"><input type="checkbox"/></td> <td style="padding: 2px; text-align: center;"><input type="checkbox"/></td> </tr> <tr> <td style="padding: 2px;">White</td> <td style="padding: 2px; text-align: center;"><input type="checkbox"/></td> <td style="padding: 2px; text-align: center;"><input type="checkbox"/></td> <td style="padding: 2px; text-align: center;"><input type="checkbox"/></td> <td style="padding: 2px; text-align: center;">Not Available</td> <td style="padding: 2px; text-align: center;"><input type="checkbox"/></td> <td style="padding: 2px; text-align: center;"><input type="checkbox"/></td> </tr> <tr> <td style="padding: 2px;">Chrome</td> <td style="padding: 2px; text-align: center;"><input type="checkbox"/></td> <td style="padding: 2px; text-align: center;"><input type="checkbox"/></td> <td style="padding: 2px; text-align: center;">Not Available</td> <td style="padding: 2px; text-align: center;"><input type="checkbox"/></td> <td style="padding: 2px; text-align: center;">Not Available</td> <td style="padding: 2px; text-align: center;"><input type="checkbox"/></td> </tr> <tr> <td style="padding: 2px;">Silver</td> <td style="padding: 2px; text-align: center;"><input type="checkbox"/></td> <td style="padding: 2px; text-align: center;"><input type="checkbox"/></td> <td style="padding: 2px; text-align: center;">Not Available</td> <td style="padding: 2px; text-align: center;">Not Available</td> <td style="padding: 2px; text-align: center;">Not Available</td> <td style="padding: 2px; text-align: center;"><input type="checkbox"/></td> </tr> </tbody> </table>	Urn Knocker	Urn with Spy	Lions Head	Spy Hole	Slim Um	Slim Urn with Spy	Letter Plate	Gold	<input type="checkbox"/>	<input type="checkbox"/>	Not Available	<input type="checkbox"/>	<input type="checkbox"/>	<input type="checkbox"/>	Brass	<input type="checkbox"/>	<input type="checkbox"/>	<input type="checkbox"/>	Not Available	Not Available	Not Available	Black	<input type="checkbox"/>	<input type="checkbox"/>	<input type="checkbox"/>	Not Available	<input type="checkbox"/>	<input type="checkbox"/>	White	<input type="checkbox"/>	<input type="checkbox"/>	<input type="checkbox"/>	Not Available	<input type="checkbox"/>	<input type="checkbox"/>	Chrome	<input type="checkbox"/>	<input type="checkbox"/>	Not Available	<input type="checkbox"/>	Not Available	<input type="checkbox"/>	Silver	<input type="checkbox"/>	<input type="checkbox"/>	Not Available	Not Available	Not Available	<input type="checkbox"/>
Urn Knocker	Urn with Spy	Lions Head	Spy Hole	Slim Um	Slim Urn with Spy	Letter Plate																																												
Gold	<input type="checkbox"/>	<input type="checkbox"/>	Not Available	<input type="checkbox"/>	<input type="checkbox"/>	<input type="checkbox"/>																																												
Brass	<input type="checkbox"/>	<input type="checkbox"/>	<input type="checkbox"/>	Not Available	Not Available	Not Available																																												
Black	<input type="checkbox"/>	<input type="checkbox"/>	<input type="checkbox"/>	Not Available	<input type="checkbox"/>	<input type="checkbox"/>																																												
White	<input type="checkbox"/>	<input type="checkbox"/>	<input type="checkbox"/>	Not Available	<input type="checkbox"/>	<input type="checkbox"/>																																												
Chrome	<input type="checkbox"/>	<input type="checkbox"/>	Not Available	<input type="checkbox"/>	Not Available	<input type="checkbox"/>																																												
Silver	<input type="checkbox"/>	<input type="checkbox"/>	Not Available	Not Available	Not Available	<input type="checkbox"/>																																												
<i>(Certain accessories not applicable with glazed options)</i>																																																		

Special Instructions if required:

CUSTOMER SPECIFICATION

ORDER FORM

ROUTE	
<i>Invoice Address:</i>	<i>Delivery Address:</i>
<i>Order No:</i>	<i>Date Required:</i> / /
<i>Date:</i> / /	<i>Ref:</i>
	<i>Contact:</i>

SIDE PANELS

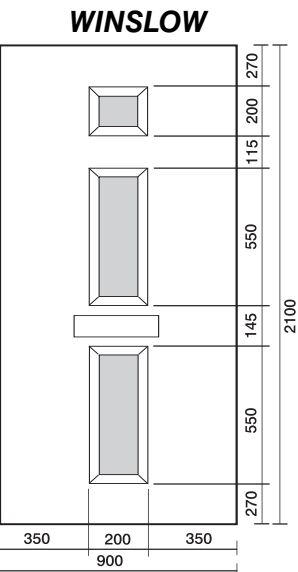
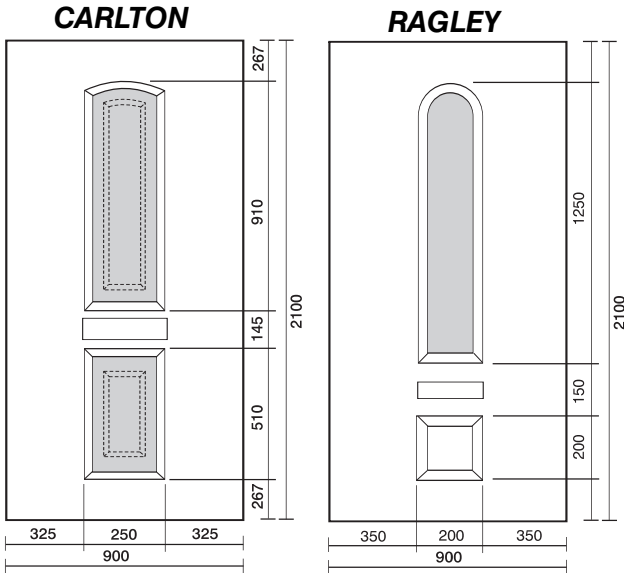

PLEASE NOTE. WHEN SUPPLIED WITH LETTERPLATE
MINIMUM CUT:
400mm CARLTON CLASSIC
400mm RAGLEY
400mm WINSLOW

SHADED AREA INDICATES
GLAZING AREAS

CARLTON CLASSIC SOLID <input type="checkbox"/> One <input type="checkbox"/> Two <input type="checkbox"/>	
RAGLEY SOLID <input type="checkbox"/> One <input type="checkbox"/>	
WINSLOW SOLID <input type="checkbox"/> One <input type="checkbox"/> Two <input type="checkbox"/> Three <input type="checkbox"/>	
<i>Door Panel Colour/Profile</i> _____	
<i>Panel Thickness:</i> <input style="width: 80px;" type="text"/> mm	<i>Panel Quantity:</i> <input style="width: 80px;" type="text"/>
<i>Reinforcing (Tick if required)</i>	
4mm Mdf <input type="checkbox"/> Aluminium <input type="checkbox"/> 9mm Mdf <input type="checkbox"/> Solid Mdf <input type="checkbox"/>	
<i>Cut to size (if required)</i>	
<i>Width</i> _____ mm x (<i>Height</i> _____ mm)	
<i>Min Cut: CARLTON W300mm H1615mm RAGLEY W250mm H1650mm</i>	
<i>Min Cut: WINSLOW W250mm H1610mm</i>	
<i>Glass Design Required:</i> _____	
<i>Backing Glass Pattern:</i> _____	
<i>Spacer Bar Colour:</i> _____	
<i>Silver Spacer Bar as standard subject to design</i>	
<i>(Certain accessories not applicable with glazed options)</i>	

Accessories (Tick extras required)		<i>Letter Plate</i>
<small>N.B. Letter Plate fitted in midrail as standard.</small>		
<i>Gold</i>	<input type="checkbox"/>	<input type="checkbox"/>
<i>Brass</i>	<input type="checkbox"/>	<small>Not Available</small>
<i>Black</i>	<input type="checkbox"/>	<input type="checkbox"/>
<i>White</i>	<input type="checkbox"/>	<input type="checkbox"/>
<i>Chrome</i>	<input type="checkbox"/>	<input type="checkbox"/>
<i>Silver</i>	<input type="checkbox"/>	<input type="checkbox"/>

All other accessories supplied loose if required

FAX SALES LINE

01482 701185

PHOTOCOPY THIS SHEET BEFORE COMPLETING & FAXING WITH YOUR OFFICIAL ORDER

**HALLMARK
PANELS LIMITED**

Valletta House, Valletta Street, Hedon Road, Hull. HU9 5NP
Customer Service: +44 (0)1482 703222, Fax: +44 (0)1482 701185, Reception: +44 (0)1482 781111

All dimensions are approximate and within manufacturing tolerances of +/-3mm. However, due to our policy of continuous development, we reserve the right to change specifications without notice

CUSTOMER SPECIFICATION

ORDER FORM

<i>ROUTE</i>		
<i>Invoice Address:</i>	<i>Delivery Address:</i>	
	<i>Date Required:</i> / /	
<i>Order No:</i>	<i>Ref:</i>	
<i>Date:</i> / /	<i>Contact:</i>	

HALF PANELS Sheet One

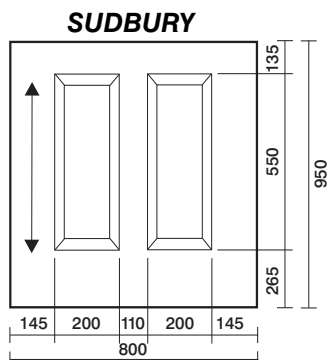
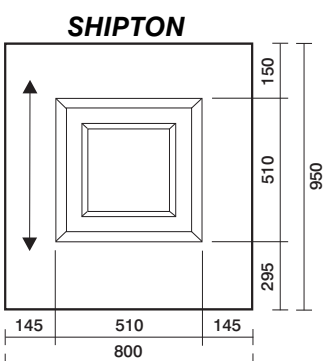
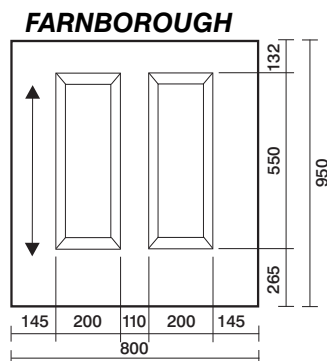
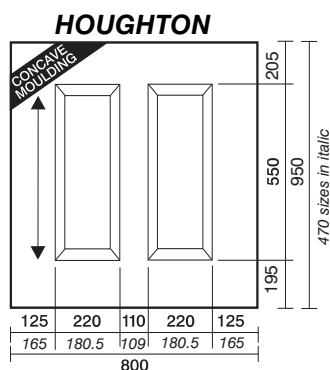
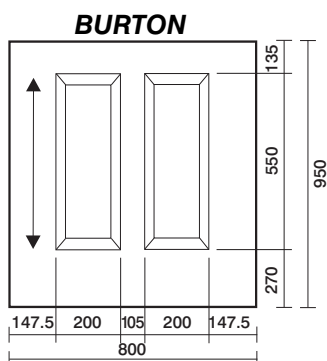

<i>Panel Type Required:</i>	
<i>Door Panel Colour/Profile</i> _____	
<i>Panel Thickness:</i> <input type="text"/> mm	<i>Panel Quantity:</i> <input type="text"/>
<i>Reinforcing (Tick if required)</i>	
4mm Plywood <input type="checkbox"/>	Steel <input type="checkbox"/>
9mm Mdf <input type="checkbox"/>	Solid Mdf <input type="checkbox"/>
<i>Cut to size (if required)</i>	
<i>Width</i> _____ <i>mm</i>) x (<i>Height</i> _____ <i>mm</i>)	

Minimum Sizes (mm)

BURTON	Min Cut: width 555 Height 600
FARNBOROUGH	Min Cut: width 560 Height 600
HOUGHTON	Min Cut: width 600 Height 600
HOUGHTON 470	Min Cut: width 520 Height 600
SHIPTON	Min Cut: width 560 Height 560
SUDBURY	Min Cut: width 560 Height 600

Special Instructions:

NOTE ← → *Direction of Woodgrain*

FAX SALES LINE
01482 701185
PHOTOCOPY THIS SHEET BEFORE COMPLETING
& FAXING WITH YOUR OFFICIAL ORDER

**HALLMARK
PANELS LIMITED**

Valletta House, Valletta Street, Hedon Road, Hull. HU9 5NP
Customer Service: +44 (0)1482 703222, Fax: +44 (0)1482 701185, Reception: +44 (0)1482 781111

All dimensions are approximate and within manufacturing tolerances of +/-3mm. However, due to our policy of continuous development, we reserve the right to change specifications without notice

CUSTOMER SPECIFICATION

ORDER FORM

<i>ROUTE</i>		
<i>Invoice Address:</i>	<i>Delivery Address:</i>	
<i>Order No.:</i>	<i>Date Required:</i> / /	
<i>Date:</i> / /	<i>Ref:</i>	
		<i>Contact:</i>

HALF PANELS Sheet Two

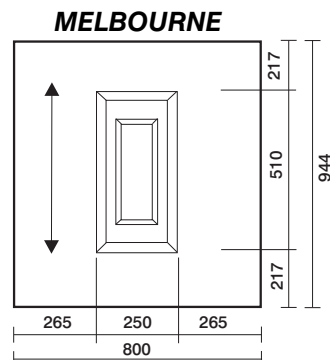
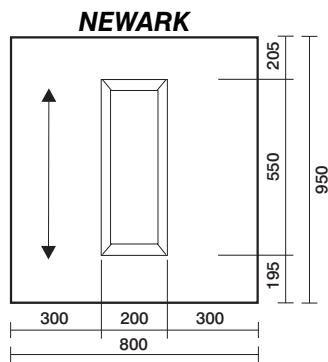
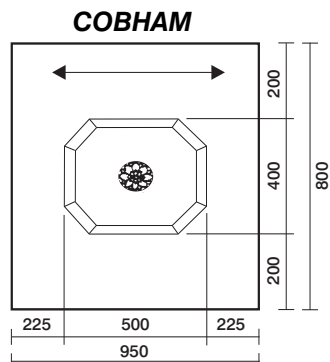
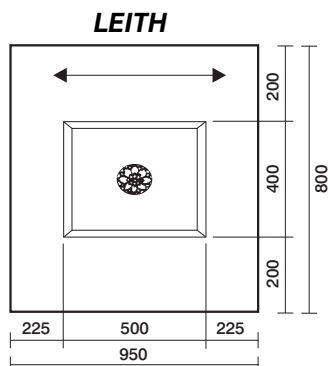
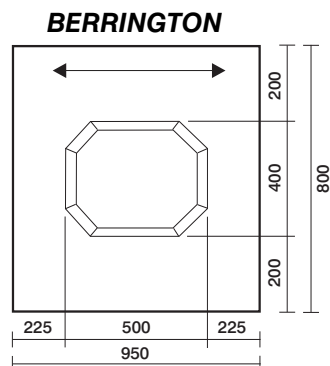

<i>Panel Type Required:</i>	
<i>Door Panel Colour/Profile</i> _____	
<i>Panel Thickness:</i> <input style="width: 50px;" type="text"/> mm	<i>Panel Quantity:</i> <input style="width: 50px;" type="text"/>
<i>Reinforcing (Tick if required)</i>	
4mm Plywood <input type="checkbox"/>	Steel <input type="checkbox"/>
9mm Mdf <input type="checkbox"/>	Solid Mdf <input type="checkbox"/>
<i>Cut to size (if required)</i>	
Width _____ mm) x (Height _____ mm)	

<i>Minimum Sizes (mm)</i>	
BERRINGTON	Min Cut: width 550 Height 450
COBHAM	Min Cut: width 550 Height 450
LEITH	Min Cut: width 550 Height 450
MELBOURNE	Min Cut: width 300 Height 560
NEWARK	Min Cut: width 250 Height 600

Special Instructions:

FAX SALES LINE
01482 701185
PHOTOCOPY THIS SHEET BEFORE COMPLETING
& FAXING WITH YOUR OFFICIAL ORDER

NOTE \longleftrightarrow *Direction of Woodgrain*

All dimensions are approximate and within manufacturing tolerances of +/-3mm. However, due to our policy of continuous development, we reserve the right to change specifications without notice

**HALLMARK
PANELS LIMITED**

CUSTOMER SPECIFICATION

ORDER FORM

ROUTE	
Invoice Address:	Delivery Address:
	Date Required: / /
Order No:	Ref:
Date: / /	Contact:

QUARTER PANELS

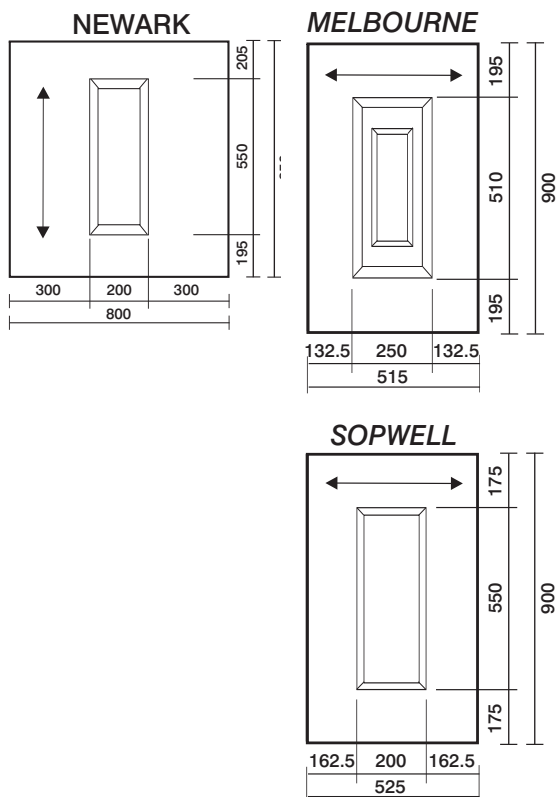

Panel Type Required:	
Door Panel Colour/Profile _____	
Panel Thickness: <input type="text"/> mm	Panel Quantity: <input type="text"/>
Reinforcing (Tick if required)	
4mm Plywood <input type="checkbox"/>	Steel <input type="checkbox"/>
9mm Mdf <input type="checkbox"/>	Solid Mdf <input type="checkbox"/>
Cut to size (if required) Width _____ mm) x (Height _____ mm)	

<i>Minimum Sizes (mm)</i>	
NEWARK	Min Cut: width 250 Height 600
MELBOURNE	Min Cut: width 300 Height 560
SOPWELL	Min Cut: width 250 Height 600

Special Instructions:
 Newark and Melbourne half panels are available with **vertical woodgrain**.
 See half panel drawing and price list.

NOTE ← → *Direction of Woodgrain*

FAX SALES LINE
01482 701185
 PHOTOCOPY THIS SHEET BEFORE COMPLETING
 & FAXING WITH YOUR OFFICIAL ORDER

**HALLMARK
 PANELS LIMITED**

Valletta House, Valletta Street, Hedon Road, Hull. HU9 5NP
 Customer Service: +44 (0)1482 703222, Fax: +44 (0)1482 701185, Reception: +44 (0)1482 781111

All dimensions are approximate and within manufacturing tolerances of +/-3mm. However, due to our policy of continuous development, we reserve the right to change specifications without notice

CUSTOMER SPECIFICATION

ORDER FORM

<i>ROUTE</i>	
<i>Invoice Address:</i>	<i>Delivery Address:</i>
<i>Order No:</i>	<i>Date Required:</i> / /
<i>Date:</i> / /	<i>Ref:</i>
	<i>Contact:</i>

CONSERVATORY/HALF PANELS

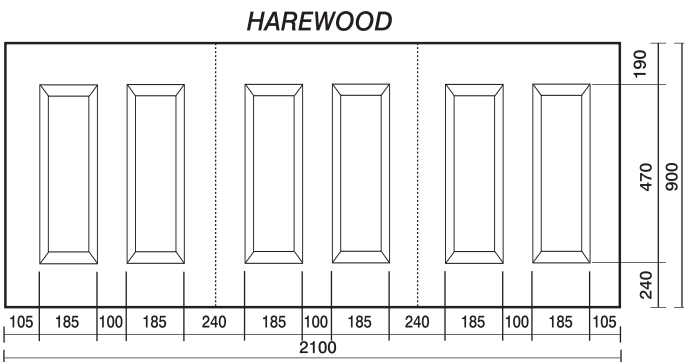
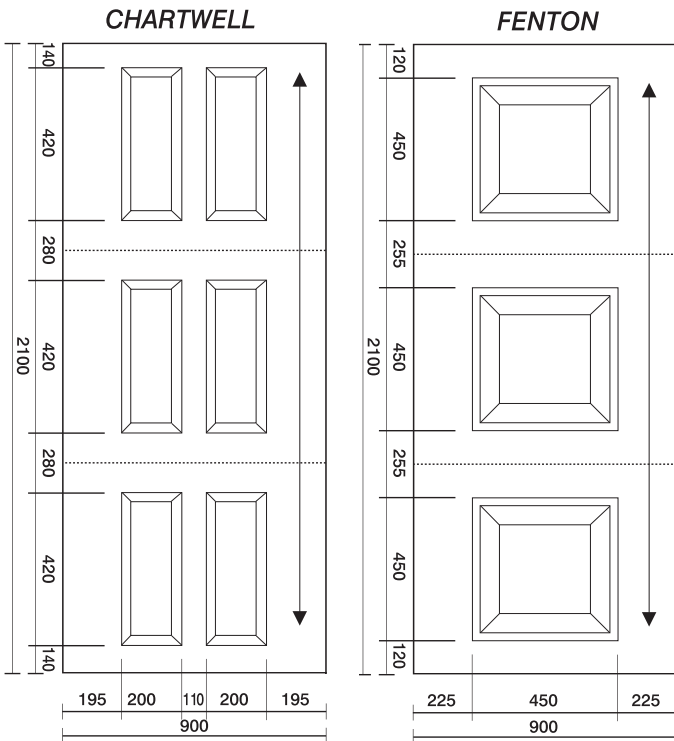

<i>Panel Type Required:</i>	
<i>Door Panel Colour/Profile</i> _____	
<i>Panel Thickness:</i> <input type="text"/> mm	<i>Panel Quantity:</i> <input type="text"/>
<i>Reinforcing (Tick if required)</i>	
4mm Plywood <input type="checkbox"/>	Steel <input type="checkbox"/>
9mm Mdf <input type="checkbox"/>	Solid Mdf <input type="checkbox"/>
<i>Cut to size (if required)</i>	
<i>Width</i> _____ <i>mm</i> x (<i>Height</i> _____ <i>mm</i>)	

Special Instructions if required:

NOTE ← → *Direction of Woodgrain*

FAX SALES LINE

01482 701185

PHOTOCOPY THIS SHEET BEFORE COMPLETING & FAXING WITH YOUR OFFICIAL ORDER

All dimensions are approximate and within manufacturing tolerances of +/-3mm. However, due to our policy of continuous development, we reserve the right to change specifications without notice

HALLMARK
PANELS LIMITED

Valletta House, Valletta Street, Hedon Road, Hull. HU9 5NP
Customer Service: +44 (0)1482 703222, Fax: +44 (0)1482 701185, Reception: +44 (0)1482 781111

ROUTE			
<i>Invoice Address:</i>	<i>Delivery Address:</i>		
	<i>Date Required:</i> / /		
<i>Order No:</i>	<i>Ref:</i>		
<i>Date:</i> / /	<i>Contact:</i>		

CONSERVATORY PANELS

Sheet One

NEWARK

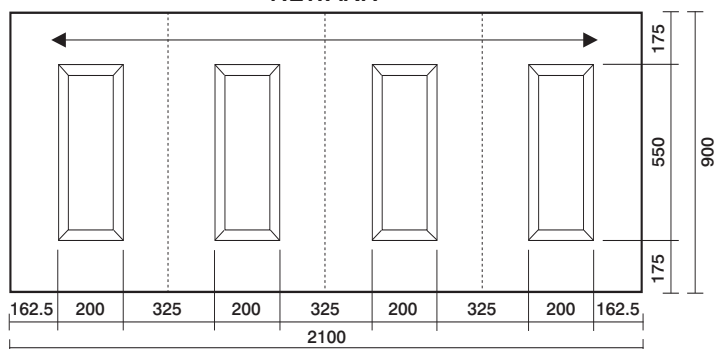

MELBOURNE

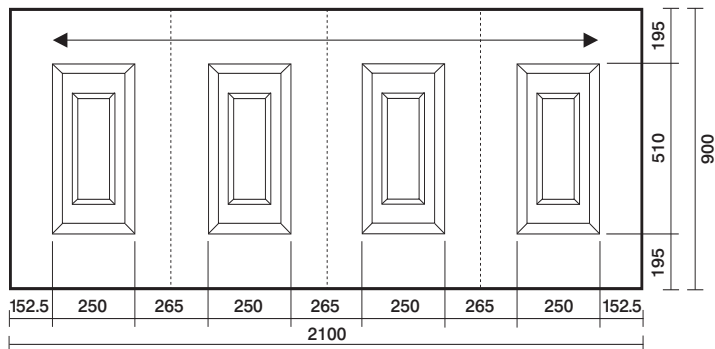

SOPWELL

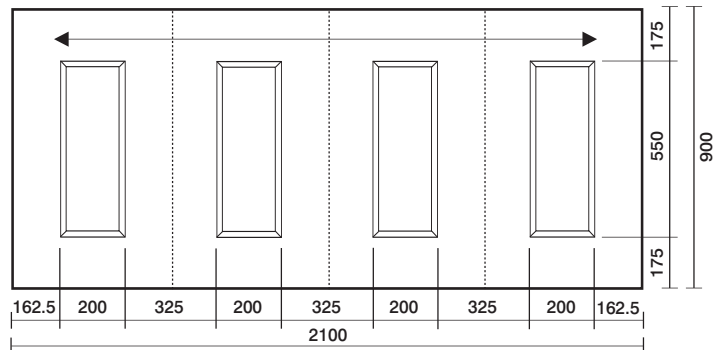

<i>Panel Type Required:</i>	
<i>Door Panel Colour/Profile</i> _____	
<i>Panel Thickness:</i> <input type="text"/> mm	<i>Panel Quantity:</i> <input type="text"/>
<i>Reinforcing (Tick if required)</i>	
4mm Plywood <input type="checkbox"/>	Steel <input type="checkbox"/>
9mm Mdf <input type="checkbox"/>	Solid Mdf <input type="checkbox"/>
<i>Cut to size (if required)</i>	
<i>Width</i> _____ mm x (<i>Height</i> _____ mm)	

Special Instructions if required:

NOTE \longleftrightarrow *Direction of Woodgrain*

FAX SALES LINE
01482 70 1185
 PHOTOCOPY THIS SHEET BEFORE COMPLETING
 & FAXING WITH YOUR OFFICIAL ORDER

All dimensions are approximate and within manufacturing tolerances of +/-3mm. However, due to our policy of continuous development, we reserve the right to change specifications without notice

<i>ROUTE</i>		
<i>Invoice Address:</i>	<i>Delivery Address:</i>	
<i>Order No:</i>	<i>Date Required:</i> / /	
<i>Date:</i> / /	<i>Ref:</i>	
		<i>Contact:</i>

CONSERVATORY PANELS

Sheet Two

ABBERLEY

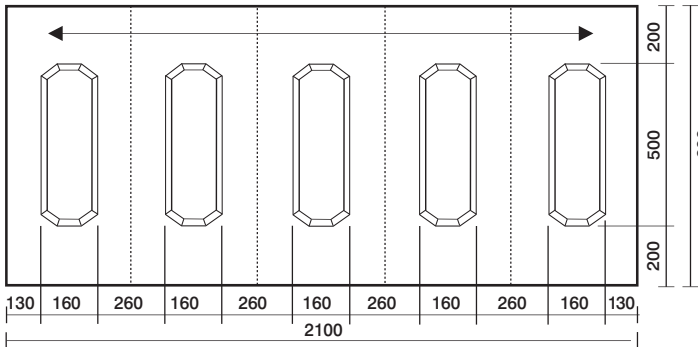

WALCOT

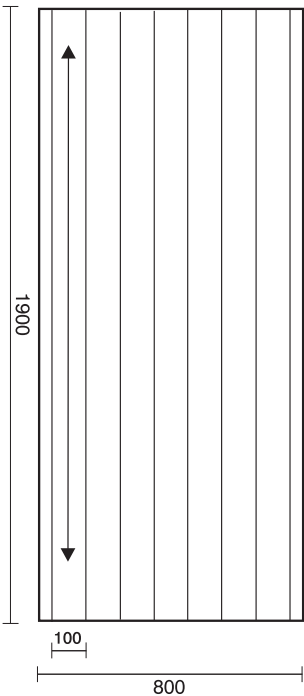

RAMSIDE

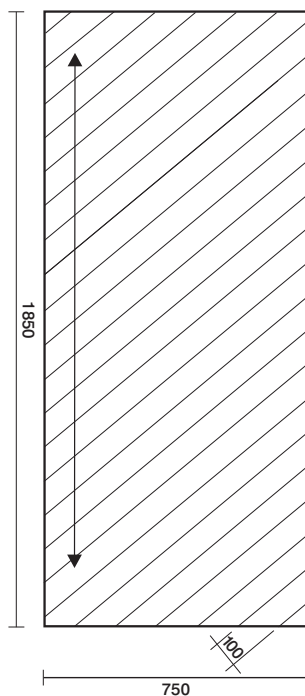

WALCOT IS AVAILABLE IN EURO SIZES (2000mm x 850mm)
MUST SPECIFY IF REQUIRED IN SPECIAL INSTRUCTIONS

<i>Panel Type Required:</i>	
<i>Door Panel</i> <i>Colour/Profile</i> _____	
<i>Panel Thickness:</i> <input type="text"/> mm	<i>Panel Quantity:</i> <input type="text"/>
<i>Reinforcing (Tick if required)</i>	
4mm Plywood <input type="checkbox"/>	Steel <input type="checkbox"/>
9mm Mdf <input type="checkbox"/>	Solid Mdf <input type="checkbox"/>
<i>Cut to size (if required)</i> <i>Width</i> _____ mm) x (<i>Height</i> _____ mm)	

<i>Special Instructions:</i>
NOTE ← → Direction of Woodgrain

FAX SALES LINE
01482 701185
PHOTOCOPY THIS SHEET BEFORE COMPLETING
& FAXING WITH YOUR OFFICIAL ORDER

All dimensions are approximate and within manufacturing tolerances of +/-3mm. However, due to our policy of continuous development, we reserve the right to change specifications without notice

CUSTOMER SPECIFICATION

ORDER FORM

ROUTE	
Invoice Address:	Delivery Address:
Date Required: / /	
Order No:	Ref:
Date: / /	Contact:

WOODGRAIN FLAT PANELS/WOODGRAIN WHITE

<p>Sizes</p> <table style="width: 100%; border-collapse: collapse;"> <thead> <tr> <th style="text-align: left;">Height</th> <th style="text-align: left;">Width</th> <th style="text-align: center;">✓</th> <th style="text-align: left;">QTY</th> </tr> </thead> <tbody> <tr> <td>2100mm x 900mm</td> <td></td> <td style="text-align: center;"><input type="checkbox"/></td> <td>_____</td> </tr> <tr> <td>1945mm x 845mm</td> <td></td> <td style="text-align: center;"><input type="checkbox"/></td> <td>_____</td> </tr> <tr> <td>1075mm x 950mm</td> <td></td> <td style="text-align: center;"><input type="checkbox"/></td> <td>_____</td> </tr> <tr> <td>970mm x 845mm</td> <td></td> <td style="text-align: center;"><input type="checkbox"/></td> <td>_____</td> </tr> </tbody> </table> <p>Door Panel Colour/Profile: _____</p> <p>Panel Thickness: _____ mm</p>	Height	Width	✓	QTY	2100mm x 900mm		<input type="checkbox"/>	_____	1945mm x 845mm		<input type="checkbox"/>	_____	1075mm x 950mm		<input type="checkbox"/>	_____	970mm x 845mm		<input type="checkbox"/>	_____	<p>Reinforced with 4mm, 9mm Mdf or Aluminium included in the price, please tick preference</p> <p>4mm MDF <input type="checkbox"/> 9mm Mdf <input type="checkbox"/></p> <p>Vertical Grain <input type="checkbox"/> Horizontal Grain <input type="checkbox"/></p> <p>Cut to size details (if required) H _____ mm x W _____ mm</p> <p>Offcuts Required: Yes <input type="checkbox"/> No <input type="checkbox"/></p> <p>Special Instructions: Please note the grain runs vertical on height of panel as indicated on drawing.</p>	<p>OPTIMISING AND CUT TO SIZE SERVICE AVAILABLE</p>
Height	Width	✓	QTY																			
2100mm x 900mm		<input type="checkbox"/>	_____																			
1945mm x 845mm		<input type="checkbox"/>	_____																			
1075mm x 950mm		<input type="checkbox"/>	_____																			
970mm x 845mm		<input type="checkbox"/>	_____																			

WHITE FLAT PANELS

<p>Sizes</p> <table style="width: 100%; border-collapse: collapse;"> <thead> <tr> <th style="text-align: left;">Height</th> <th style="text-align: left;">Width</th> <th style="text-align: center;">✓</th> <th style="text-align: left;">QTY</th> </tr> </thead> <tbody> <tr> <td>3000mm x 1500mm</td> <td></td> <td style="text-align: center;"><input type="checkbox"/></td> <td>_____</td> </tr> <tr> <td>3000mm x 750mm</td> <td></td> <td style="text-align: center;"><input type="checkbox"/></td> <td>_____</td> </tr> <tr> <td>2150mm x 950mm</td> <td></td> <td style="text-align: center;"><input type="checkbox"/></td> <td>_____</td> </tr> <tr> <td>1945mm x 845mm</td> <td></td> <td style="text-align: center;"><input type="checkbox"/></td> <td>_____</td> </tr> <tr> <td>1075mm x 950mm</td> <td></td> <td style="text-align: center;"><input type="checkbox"/></td> <td>_____</td> </tr> <tr> <td>970mm x 845mm</td> <td></td> <td style="text-align: center;"><input type="checkbox"/></td> <td>_____</td> </tr> </tbody> </table> <p>Door Panel Colour/Profile: _____</p> <p>Panel Thickness: _____ mm</p>	Height	Width	✓	QTY	3000mm x 1500mm		<input type="checkbox"/>	_____	3000mm x 750mm		<input type="checkbox"/>	_____	2150mm x 950mm		<input type="checkbox"/>	_____	1945mm x 845mm		<input type="checkbox"/>	_____	1075mm x 950mm		<input type="checkbox"/>	_____	970mm x 845mm		<input type="checkbox"/>	_____	<p>Reinforced:- please tick as required</p> <p>4mm MDF <input type="checkbox"/> Aluminium <input type="checkbox"/> <small>(3mtrs only)</small></p> <p>9mm Mdf <input type="checkbox"/> 12mm Mdf <input type="checkbox"/> <small>(n/a on 3mtrs) (3mtrs only)</small></p> <p>Cut to size details (if required) H _____ mm x W _____ mm</p> <p>Offcuts Required: Yes <input type="checkbox"/> No <input type="checkbox"/></p>	<p>OPTIMISING AND CUT TO SIZE SERVICE AVAILABLE</p>
Height	Width	✓	QTY																											
3000mm x 1500mm		<input type="checkbox"/>	_____																											
3000mm x 750mm		<input type="checkbox"/>	_____																											
2150mm x 950mm		<input type="checkbox"/>	_____																											
1945mm x 845mm		<input type="checkbox"/>	_____																											
1075mm x 950mm		<input type="checkbox"/>	_____																											
970mm x 845mm		<input type="checkbox"/>	_____																											

<p>FAX SALES LINE</p> <p style="font-size: 2em; margin: 0;">01482</p> <p style="font-size: 3em; margin: 0;">701185</p>	<p>PHOTOCOPY THIS SHEET BEFORE COMPLETING & FAXING WITH YOUR OFFICIAL ORDER</p>
---	--

**HALLMARK
PANELS LIMITED**

Valletta House, Valletta Street, Hedon Road, Hull. HU9 5NP
Customer Service: +44 (0)1482 703222, Fax: +44 (0)1482 701185, Reception: +44 (0)1482 781111

All dimensions are approximate and within manufacturing tolerances of +/-3mm. However, due to our policy of continuous development, we reserve the right to change specifications without notice

VARIATIONS/ON HOLD/CANCELLATIONS OF ORDERS

THIS FORM MUST BE COMPLETED FOR ALL AMENDMENTS/ON HOLD/CANCELLATIONS

To:	Date:
-----	-------

(Tick as required)

I/We would like to: **Hold** to my/our original order.
 Change to my/our original order.
 Cancel to my/our original order.

Order No:	Reference:
-----------	------------

Placed:

<i>The items details are as follows:-</i>

<i>The change(s) I/we would like to make are as follows:-</i>

Please confirm that this is acceptable Yes No

From:	Hallmark Authorisation
Company:	

This must be signed and returned to the customer

**HALLMARK
PANELS LIMITED**

Valletta House, Valletta Street, Hedon Road, Hull. HU9 5NP
Customer Service: +44 (0)1482 703222, Fax: +44 (0)1482 701185, Reception: +44 (0)1482 781111

All dimensions are approximate and within manufacturing tolerances of +/-3mm. However, due to our policy of continuous development, we reserve the right to change specifications without notice

